

ALGIZ RT7

QUICK START GUIDE



handheld

1 WHAT'S IN THE BOX

The pictures shown below may differ from the actual products. To purchase additional or optional products, contact our customer centre.

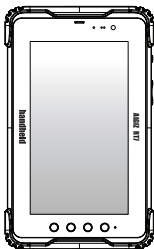

Algiz RT7 Main Body

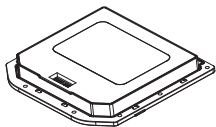

Battery Pack



x 9 pcs

Battery Screws

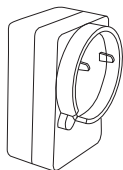

Charging Adaptor



3.5mm Barrel
Connector Cable



Micro USB
Cable



Headset

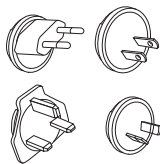

Converter Plugs

2 YOUR ALGIZ RT7

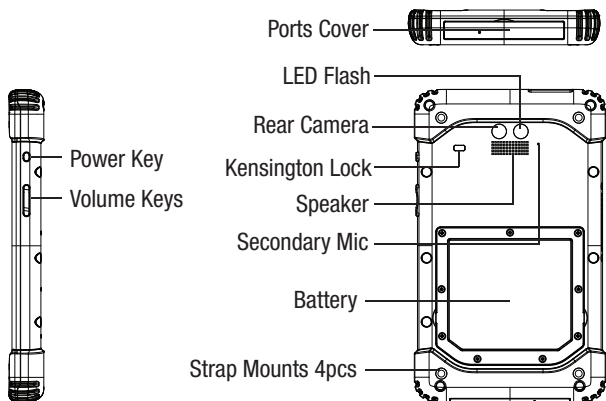
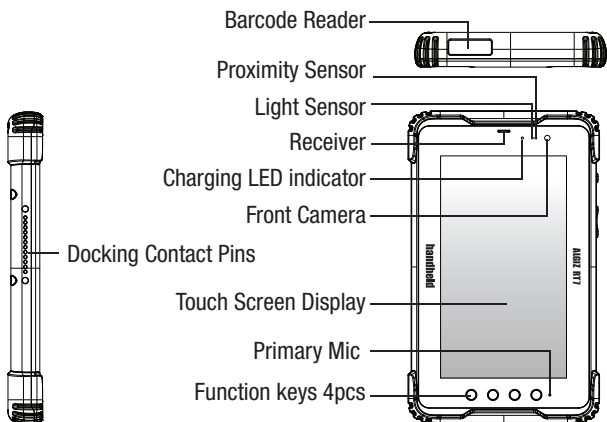

3 INSERTING/EXTRACTING SIM/MICRO SD CARD

This is how you insert and remove the SIM/ micro SD.

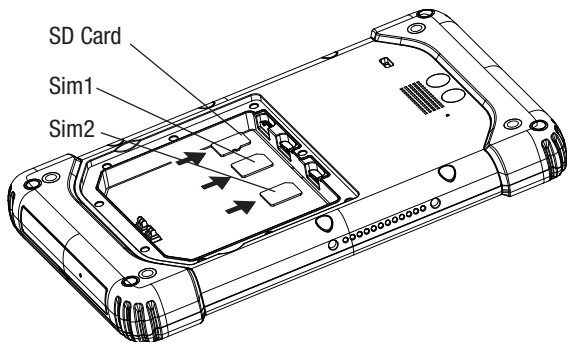

4 INSERT/REMOVE BATTERY

To insert the battery

1. Place the battery pack on the back as shown.
2. Using the battery screws (M2 X 5mm) fasten them in position.

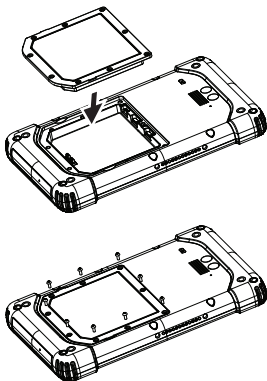

To remove the battery

1. Power off the device.
2. Open the battery cover by unfastening the screws.
3. Remove the battery pack.

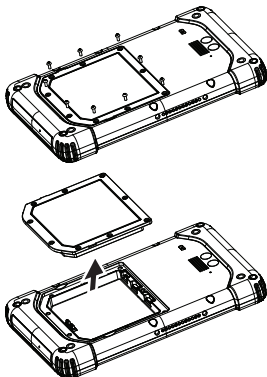

5 POWERING ON/OFF

Press the [Power] button on the right side of the device to turn the Algiz RT7 unit on/off.

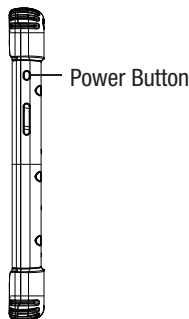

6 BATTERY CHARGING

Charge the unit for 3 hours before using the device for the first time.

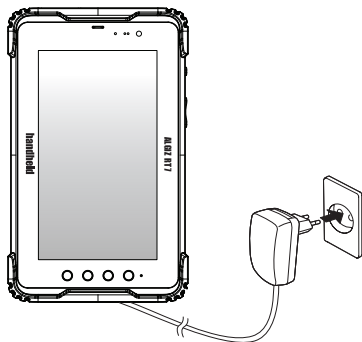

7 I/O COMPARTMENT LAYOUT

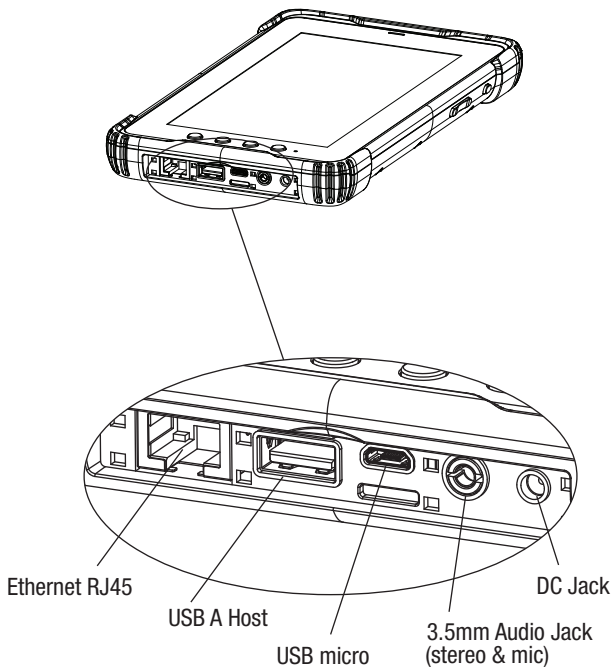

Please go to www.handheldgroup.com/knowledgebase to download more information.

handheld

www.handheldgroup.com