

---

# **ASLAN-W715/19/22C**

**Fanless Wide-Screen Industrial Panel PC  
with Intel® Quad-Core Processor J1900**

## **User's Manual**

**Version 1.1**

---

## Revision History

Version	Date	Description
1.0	February, 2015	Initial release
1.1	October, 2016	<ul style="list-style-type: none"><li>• Updated <a href="#">1.3. Specifications</a></li><li>• Added driver path for Windows 10 in <a href="#">2.3. Driver Installation Note</a></li></ul>

<b>Revision History .....</b>	<b>ii</b>
<b>Contents .....</b>	<b>i</b>
<b>Preface.....</b>	<b>iii</b>
Copyright Notice .....	iii
Declaration of Conformity .....	iii
CE.....	iii
FCC Class A .....	iii
RoHS .....	iv
SVHC / REACH .....	iv
Important Safety Instructions .....	v
Warning.....	vi
Lithium Battery Replacement.....	vi
Technical Support .....	vi
Warranty.....	vii
<b>Chapter 1 - Introduction.....</b>	<b>1</b>
1.1. The Computer .....	2
1.2. About this Manual .....	2
1.3. Specifications.....	3
1.4. Inside the Package .....	5
1.5. Ordering Information .....	5
<b>Chapter 2 - Getting Started.....</b>	<b>7</b>
2.1. Dimensions .....	8
2.2. Tour the Computer .....	10
2.2.1. Front View.....	10
2.2.2. Rear View .....	11
2.3. Driver Installation Note.....	12
<b>Chapter 3 - Engine of the Computer.....</b>	<b>15</b>
3.1. Board Layout.....	16
3.2. Jumpers and Connectors.....	17
3.2.1. Jumpers .....	17
3.2.2. Connectors .....	23
<b>Chapter 4 - Installation and Maintenance.....</b>	<b>35</b>
4.1. Use Onboard Jumpers and Connectors .....	36
4.2. Install Hardware .....	37
4.2.1. Install SSD or HDD .....	37
4.2.2. Install Wi-Fi Module .....	39
4.3. Mount the Computer .....	40
4.3.1. Panel Mounting.....	40
4.3.2. VESA Mounting.....	41
4.4. Wire DC-Input Power Source.....	42

**Chapter 5 - BIOS ..... 43**

- 5.1. Main ..... 46
- 5.2. Advanced ..... 47
  - 5.2.1. Boot Configuration ..... 48
  - 5.2.2. PCI Express Configuration ..... 48
  - 5.2.3. USB Configuration ..... 48
  - 5.2.4. Miscellaneous Configuration ..... 49
  - 5.2.5. SATA Configuration ..... 49
  - 5.2.6. SIO Fintek 81216 ..... 49
- 5.3. Security ..... 50
- 5.4. Power ..... 51
- 5.5. Boot ..... 52
- 5.6. Exit ..... 53

**Appendices ..... 55**

- Appendix A: Wi-Fi Module Hardware Installation ..... 56
- Appendix B: Install 2nd CFast module/CFast card ..... 61

## Copyright Notice

All Rights Reserved.

The information in this document is subject to change without prior notice in order to improve the reliability, design and function. It does not represent a commitment on the part of the manufacturer.

Under no circumstances will the manufacturer be liable for any direct, indirect, special, incidental, or consequential damages arising from the use or inability to use the product or documentation, even if advised of the possibility of such damages.

This document contains proprietary information protected by copyright. All rights are reserved. No part of this document may be reproduced by any mechanical, electronic, or other means in any form without prior written permission of the manufacturer.

## Declaration of Conformity

### CE

The CE symbol on your product indicates that it is in compliance with the directives of the Union European (EU). A Certificate of Compliance is available by contacting Technical Support.

This product has passed the CE test for environmental specifications when shielded cables are used for external wiring. We recommend the use of shielded cables. This kind of cable is available from ARBOR. Please contact your local supplier for ordering information.

### Warning

This is a class A product. In a domestic environment this product may cause radio interference in which case the user may be required to take adequate measures.

### FCC Class A

This device complies with Part 15 of the FCC Rules. Operation is subject to the following two conditions:

- (1) This device may not cause harmful interference, and
- (2) This device must accept any interference received, including interference that may cause undesired operation.

### NOTE:

This equipment has been tested and found to comply with the limits for a Class A digital device, pursuant to Part 15 of the FCC Rules. These limits are designed to provide reasonable protection against harmful interference when the equipment is operated in a commercial environment. This equipment generates, uses, and can radiate radio frequency energy and, if not installed and used in accordance with the instruction manual, may cause harmful interference to radio communications. Operation of this equipment in a residential area is likely to cause harmful interference in which case the user will be required to correct the interference at his own expense.

### RoHS

ARBOR Technology Corp. certifies that all components in its products are in compliance and conform to the European Union's Restriction of Use of Hazardous Substances in Electrical and Electronic Equipment (RoHS) Directive 2002/95/EC.

The above mentioned directive was published on 2/13/2003. The main purpose of the directive is to prohibit the use of lead, mercury, cadmium, hexavalent chromium, polybrominated biphenyls (PBB), and polybrominated diphenyl ethers (PBDE) in electrical and electronic products. Member states of the EU are to enforce by 7/1/2006.

ARBOR Technology Corp. hereby states that the listed products do not contain unintentional additions of lead, mercury, hex chrome, PBB or PBDB that exceed a maximum concentration value of 0.1% by weight or for cadmium exceed 0.01% by weight, per homogenous material. Homogenous material is defined as a substance or mixture of substances with uniform composition (such as solders, resins, plating, etc.). Lead-free solder is used for all terminations (Sn(96-96.5%), Ag(3.0-3.5%) and Cu(0.5%)).

### SVHC / REACH

To minimize the environmental impact and take more responsibility to the earth we live, Arbor hereby confirms all products comply with the restriction of SVHC (Substances of Very High Concern) in (EC) 1907/2006 (REACH --Registration, Evaluation, Authorization, and Restriction of Chemicals) regulated by the European Union.

All substances listed in SVHC < 0.1 % by weight (1000 ppm)

## **Important Safety Instructions**

Read these safety instructions carefully

1. Read all cautions and warnings on the equipment.
2. Place this equipment on a reliable surface when installing. Dropping it or letting it fall may cause damage
3. Make sure the correct voltage is connected to the equipment.
4. For pluggable equipment, the socket outlet should be near the equipment and should be easily accessible.
5. Keep this equipment away from humidity.
6. The openings on the enclosure are for air convection and protect the equipment from overheating. **DO NOT COVER THE OPENINGS.**
7. Position the power cord so that people cannot step on it. Do not place anything over the power cord.
8. Never pour any liquid into opening. This may cause fire or electrical shock.
9. Never open the equipment. For safety reasons, the equipment should be opened only by qualified service personnel.
10. If one of the following situations arises, get the equipment checked by service personnel:
  - a. The power cord or plug is damaged.
  - b. Liquid has penetrated into the equipment.
  - c. The equipment has been exposed to moisture.
  - d. The equipment does not work well, or you cannot get it to work according to the user's manual.
  - e. The equipment has been dropped or damaged.
  - f. The equipment has obvious signs of breakage.
11. Keep this User's Manual for later reference.

## **Warning**

The Box PC and its components contain very delicately Integrated Circuits (IC). To protect the Box PC and its components against damage caused by static electricity, you should always follow the precautions below when handling it:

1. Disconnect your Box PC from the power source when you want to work on the inside.
2. Use a grounded wrist strap when handling computer components.
3. Place components on a grounded antistatic pad or on the bag that came with the Box PC, whenever components are separated from the system.

## **Lithium Battery Replacement**

Incorrect replacement of the lithium battery may lead to a risk of explosion.

The lithium battery must be replaced with an identical battery or a battery type recommended by the manufacturer.

Do not throw lithium batteries into the trash can. It must be disposed of in accordance with local regulations concerning special waste.

## **Technical Support**

If you have any technical difficulties, please consult the user's manual first at:  
<http://www.arbor.com.tw>

Please do not hesitate to call or e-mail our customer service when you still cannot find out the answer.

<http://www.arbor-technology.com>

E-mail:[info@arbor.com.tw](mailto:info@arbor.com.tw)



## **Warranty**

This product is warranted to be in good working order for a period of one year from the date of purchase. Should this product fail to be in good working order at any time during this period, we will, at our option, replace or repair it at no additional charge except as set forth in the following terms. This warranty does not apply to products damaged by misuse, modifications, accident or disaster.

Vendor assumes no liability for any damages, lost profits, lost savings or any other incidental or consequential damage resulting from the use, misuse of, or inability to use this product. Vendor will not be liable for any claim made by any other related party.

Vendors disclaim all other warranties, either expressed or implied, including but not limited to implied warranties of merchantability and fitness for a particular purpose, with respect to the hardware, the accompanying product's manual(s) and written materials, and any accompanying hardware. This limited warranty gives you specific legal rights.

Return authorization must be obtained from the vendor before returned merchandise will be accepted. Authorization can be obtained by calling or faxing the vendor and requesting a Return Merchandise Authorization (RMA) number. Returned goods should always be accompanied by a clear problem description.

---

This page is intentionally left blank.

---

# Chapter 1

## Introduction

## 1.1. The Computer

### Product Highlights

- 15.6" 1366 x 768/ 18.5" 1366 x 768 WXGA / 21.5" 1920 x 1080 FHD LCD Display w/ LED backlight
- Flat panel with projected capacitive touchscreen
- Front panel compliant with IP65
- Anti-scratch surface: 7H hardness
- Vertical I/O design
- Easy maintenance design for CFast/HDD/SSD
- Serial Ports (RS-232/485), w/ auto-flow Control
- Mini PCIe expansion slot support
- Fanless cooling system
- Cable-less design
- Low power consumption
- 2 x SMA antenna holes for optional WiFi Function
- 9~36V wide-range DC input

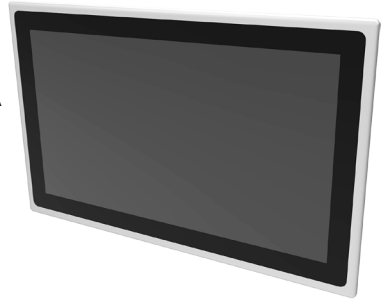

### 1.2. About this Manual

This manual is meant for the experienced users and integrators with hardware knowledge of personal computers. If you are not sure about the description in this manual, consult your vendor before further handling.

We recommend that you keep one copy of this manual for the quick reference for any necessary maintenance in the future. Thank you for choosing ARBOR products.

### 1.3. Specifications

System	
CPU	Intel® J1900 Quad-Core™ Processor 2.0GHz
Memory	4GB DDR3L SO-DIMM RAM module installed
	1 x DDR3L SO-DIMM Socket, supporting 1066/1333 MHz SDRAM up to 8GB
LAN	2 x Intel® I210AT GbE controllers
	1 x Intel® 8111E GbE controller
Watchdog Timer	1~255 levels reset
Storage	
Device	2 x outside-accessible 2.5" drive bay (default), or CFast slot (optional for OEM version)
Audio	
Speaker	2 x 2W speakers (optional)
LCD Display	
Size/Type	ASLAN-W715C: 15.6" TFT LCD Panel
	ASLAN-W719C: 18.5" TFT LCD Panel
	ASLAN-W722C: 21.5" TFT LCD Panel
Max. Resolution	ASLAN-W715C: 1366 x 768, WXGA
	ASLAN-W719C: 1366 x 768, WXGA
	ASLAN-W722C: 1920 x 1080, FHD
Max. Colors	16.2M
Luminance	ASLAN-W715C: 300 cd/m <sup>2</sup>
	ASLAN-W719C: 300 cd/m <sup>2</sup>
	ASLAN-W722C: 250 cd/m <sup>2</sup>
Touch Screen	Projected capacitive touch panel
View Angle (U/D/R/L)	80°/80°/85°/85°
Power System	
Power Input	DC 9~36V
Certification	
EMC / EMI	UL, CE, FCC Class A
Expansion	
Expansion Bus	1 x Mini-card socket (Full Size)

## Introduction

---

External I/O	
Serial Ports	2 x RS232 & 2 x RS-232/485 w/ auto flow control
USB Ports	1 x Type-A USB 3.0 port
	3 x Type-A USB 2.0 ports
LAN	3 x RJ-45 GbE ports
DVI	1 x DVI-I connector
WiFi	2 x SMA antenna holes for optional WiFi function
Mechanical	
Mounting Type	Panel mounting and VESA-100 mounting
Chassis	Panel-mounting chassis, aluminum front bezel and SECC steel chassis
Dimensions (W x D x H)	ASLAN-W715C: 404.00 x 255.00 x 49.20 mm (15.9" x 10.0" x 1.93")
	ASLAN-W719C: 470.00 x 295.00 x 49.20 mm (18.5" x 11.6" x 1.93")
	ASLAN-W722C: 536.00 x 332.00 x 48.40 mm (21.1" x 13.1" x 1.90")
Weight (Net)	ASLAN-W715C: 4.6 kg (10.14 lb)
	ASLAN-W719C: 5.7 kg (12.5 lb)
	ASLAN-W722C: 7 kg (15.4 lb)
Environmental	
Operating Temp.	-20°C ~ 55°C (-4°F ~ 140°F)
Storage Temp.	-30°C ~ 70°C (-22°F ~ 158°F)
Operating Humidity	10 ~ 95% RH @ 60°C (non-condensing)
Vibration	5 ~ 500Hz, 1Grms Random (with CFast/SSD)
Shock	Operating 10G, 11ms Non-operating 30G, 11ms (with CFast/SSD)
OS Support	
W7 Pro / WS7E / W8.1 Industry / W10 / Linux: Ubuntu	

## 1.4. Inside the Package

Upon opening the package, carefully inspect the contents. If any of the items is missing or appears damaged, contact your local dealer or distributor. The package should contain the following items:



1 x ASLAN-W715/19/22C Industrial panel PC



1 x **Accessory Box** that contains the following items:

- Driver CD
- User's manual
- Screws/cable
- 3-pin plug for terminal block

## 1.5. Ordering Information

**ASLAN-W715C-1900G4** 15.6" Intel® J1900 Quad-Core™ Processor Wide-screen industrial panel PC with 4GB Memory

**ASLAN-W719C-1900G4** 18.5" Intel® J1900 Quad-Core™ Processor Wide-screen industrial panel PC with 4GB Memory

**ASLAN-W722C-1900G4** 21.5" Intel® J1900 Quad-Core™ Processor Wide-screen industrial panel PC with 4GB Memory

---

This page is intentionally left blank.



---

# Chapter 2

## Getting Started

## 2.1. Dimensions

### ASLAN-W715C

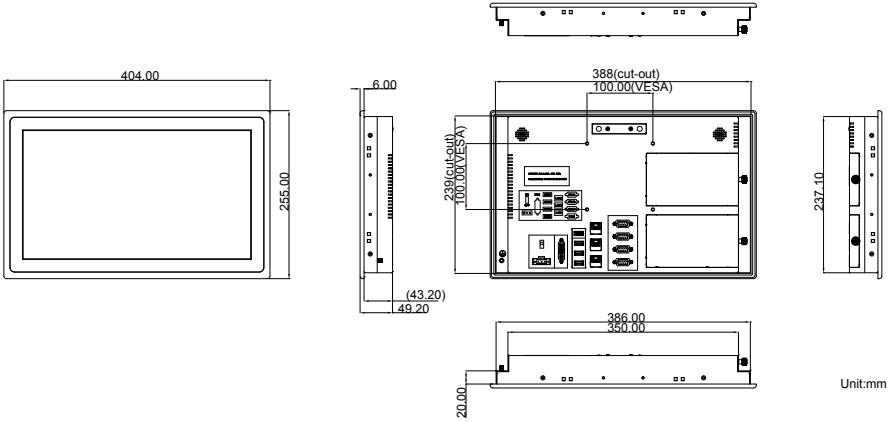

### ASLAN-W719C

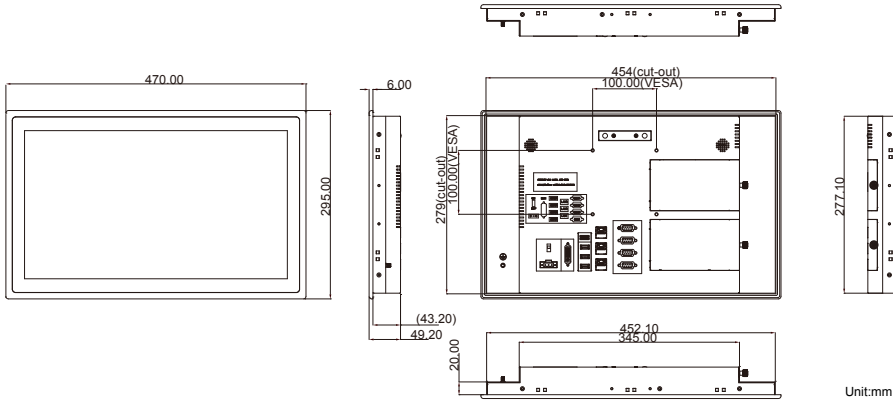

# ASLAN-W722C

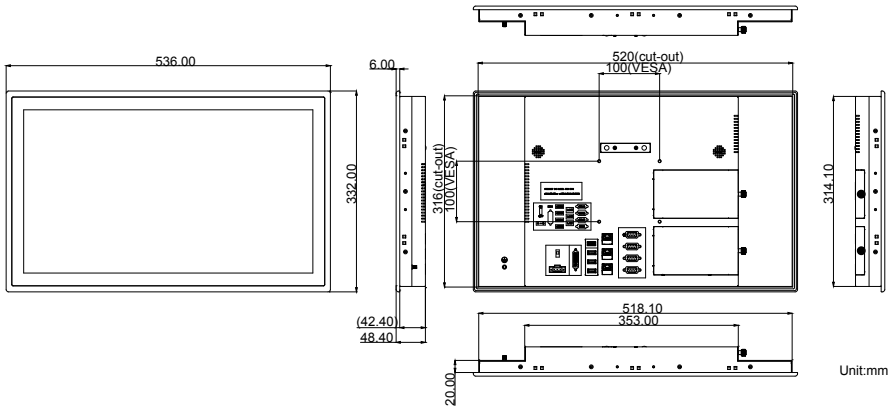

## 2.2. Tour the Computer

Take a look around the computer and find the external controls and connectors.

### 2.2.1. Front View



## 2.2.2. Rear View

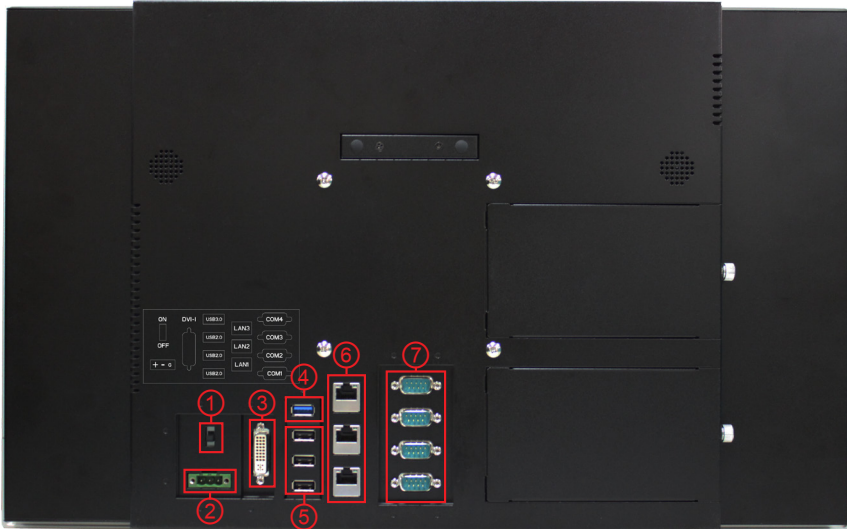

No.	Description	
①	Slide Power switch	
②	DC-IN	
③	DVI port	
④	1 x USB3.0 port	
⑤	3x USB2.0 ports	
⑥	3 x LAN ports	
⑦	COM4	COM1 and COM2 are RS-232/485 configurable. COM3 and COM4 are RS-232.
	COM3	
	COM2	
	COM1	

## 2.3. Driver Installation Note

The computer supports the operating systems Windows 7, Windows 8 and Windows 10. Find the necessary device drivers on the CD that comes with your purchase. Always follow the sequence below to install all drivers to prevent errors:

### Windows 7

Device	Driver Path
Chipset	\\CHIPSET\WIN7\infinst_autol
Graphic	\\GRAPHIC\WIN7\Intel_EMGD_WIN7_32bit_V_36_15_0_1073\SETUP
	\\GRAPHIC\WIN7\Intel_EMGD_Win7_64bit_V_37_15_0_1073\SETUP
Audio	\\AUDIO\RTL_AUDIO_Win7_Win8_Win81_32bit_R273
	\\AUDIO\RTL_AUDIO_Win7_Win8_Win81_64bit_R273
LAN	\\LAN\WIN7\PROWin32
	\\LAN\WIN7\PROWin64
	\\LAN\WIN7\Install_Win7_7085_05222014\SETUP
TXE	\\TXE\setup
KMDF	\\KMDF\kmdf-1.11-Win-6.1-x64.msu
	\\KMDF\kmdf-1.11-Win-6.1-x86.msu
USB 3.0	\\USB 3.0\WIN7\Intel_USB30_Win7_32_64bit_V3.0.0.19
NET FRAMEWORK	\\NET Framework 3.5

### Windows 8

Device	Driver Path
Chipset	\\CHIPSET\WIN8\infinst_autol
Graphic	\\GRAPHIC\WIN8\32bit\Win32\SETUP
	\\GRAPHIC\WIN8\64bit\win64\SETUP
Audio	\\AUDIO\RTL_AUDIO_Win7_Win8_Win81_32bit_R273
	\\AUDIO\RTL_AUDIO_Win7_Win8_Win81_64bit_R273
LAN	\\LAN\WIN8\PROWin32
	\\LAN\WIN8\PROWin64
	\\LAN\WIN8\Install_Win8_8.1_8031_05222014\SETUP
TXE	\\TXE\setup
MBI	\\INTEL MBI\SETUP
NET FRAMEWORK	\\NET Framework 3.5
SMSC WINUSB Driver	\\SMSC WINUSB Driver\

**Windows 10**

<b>Device</b>	<b>Driver Path</b>
<b>Chipset</b>	\\Windows 10\Inf\SetupChipset.exe
<b>Graphic</b>	\\Windows 10\Graphics\win64_153343.4425.exe
<b>Audio</b>	\\Windows 10\Audio\0006-64bit_Win7_Win8_Win81_Win10_R279.exe
<b>LAN</b>	\\Windows 10\Intel LAN\PROWinx64
<b>TXE</b>	\\Windows 10\TXE_1.1.4.1145_Win7_8.1_10\Installer\SetupTXE.exe
<b>MBI</b>	\\Windows 10\MBI\n15hn02w.exe

---

This page is intentionally left blank.



---

# Chapter 3

## Engine of the Computer

### 3.1. Board Layout

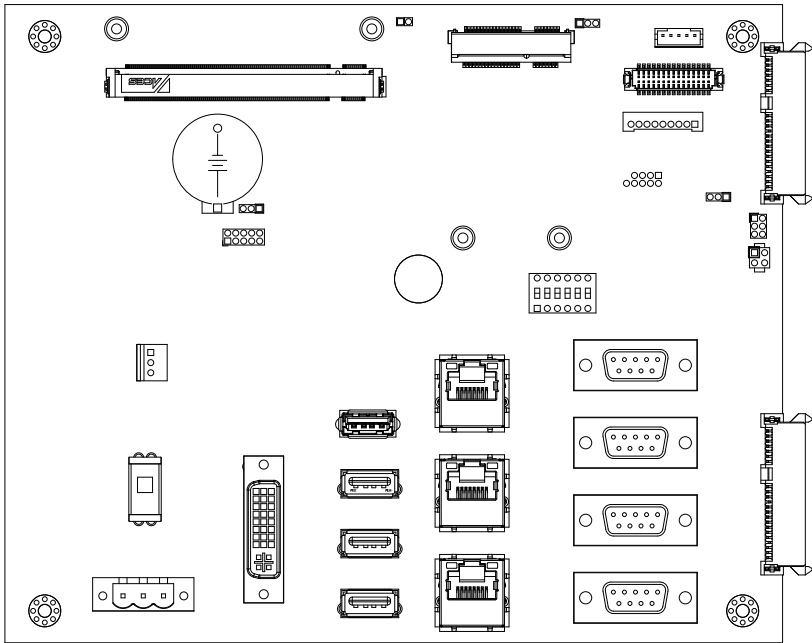

## 3.2. Jumpers and Connectors

This chapter will explicate each of the jumpers and connectors on the carrier board of the computer.

### 3.2.1. Jumpers

#### JATX1

**Function:** power supply mode setting

**Jumper Type:** 2.00mm-pitch  
1x3-pin header

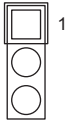

**Setting:**

Pin	Description	Setting
1-2	AT(default)	
2-3	ATX	

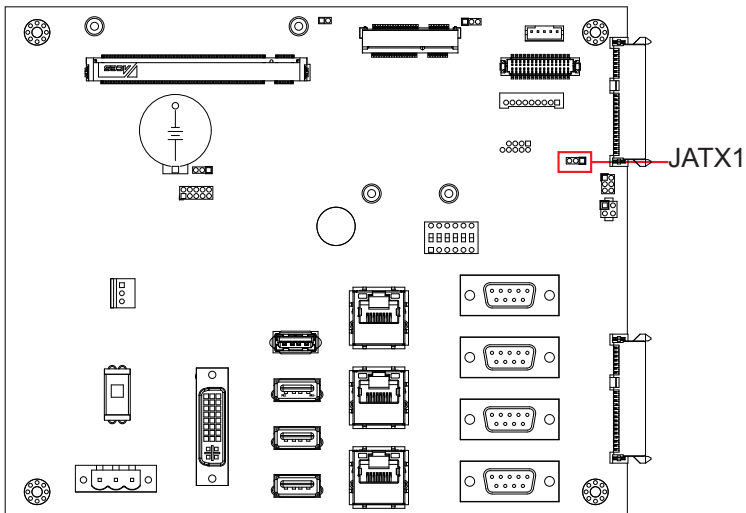



### JVLCD1

**Function:** LCD power selection

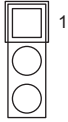
**Jumper Type:** 2.00mm-pitch  
1x3-pin header



**Setting:**

Pin	Description	Setting
1-2	3.3V	
2-3	5V (default)	

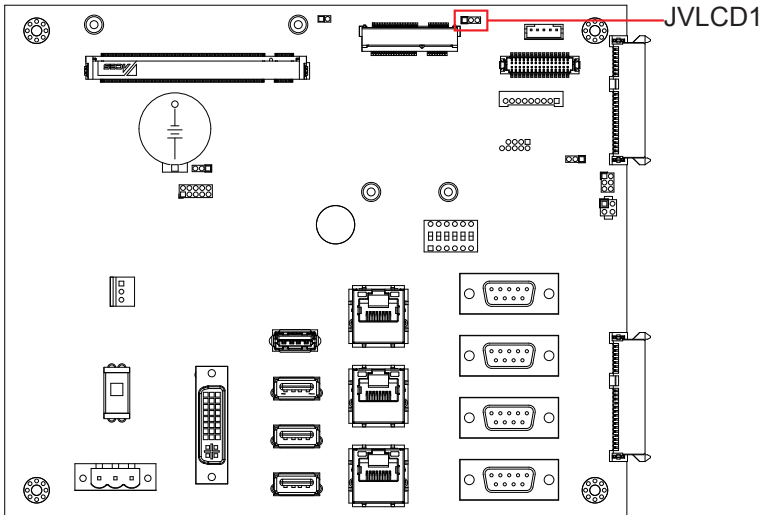

## JBAT1

**Function:** CMOS setting

**Jumper Type:** 2.00mm-pitch  
1x3-pin header

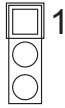

### Setting:

Pin	Description	Setting
1-2	keep CMOS (default)	
2-3	clear CMOS	

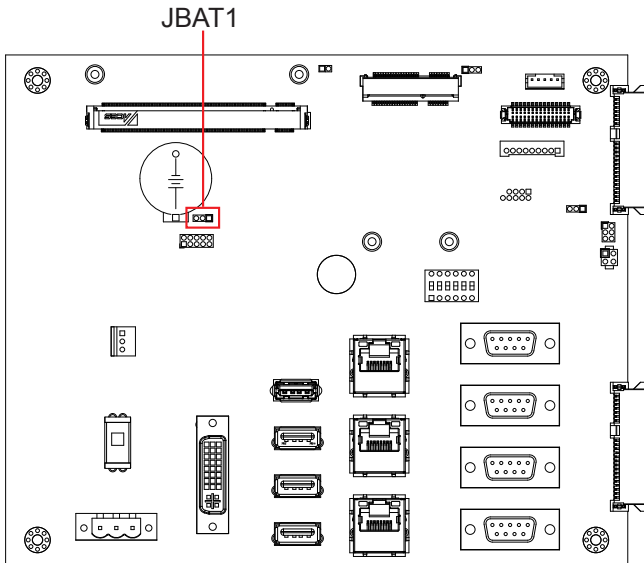

### JBIOS1

**Function:** BIOS selector  
**Jumper Type:** 2.00mm-pitch  
**1x2-pin open type jumper**



**Setting:**

Pin	Description	Setting
ON	Boot the computer from the carrier board's flash ROM BIOS. (default)	
OFF	Boot the computer from the CPU board's flash ROM BIOS.	

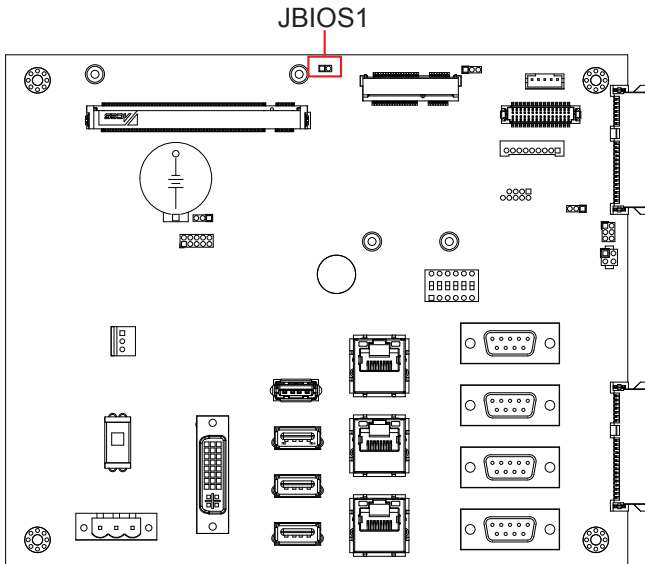

### SW1

**Function:** RS232/485 MODE Switch  
**Jumper Type:** 1 x 6-pin DIP Switch



**Setting:**

Toggle	Description	Toggle	Description
1-ON	COM1 RS485 MODE	3-ON	COM2 RS485 MODE
1-OFF	COM1 RS232 MODE	3-OFF	COM2 RS232 MODE
2-ON	COM1 RS485 with Terminal Resister	4-ON	COM2 RS485 with Terminal Resister

**Default setting:** 1~4 OFF, COM1&COM2 are RS-232 mode

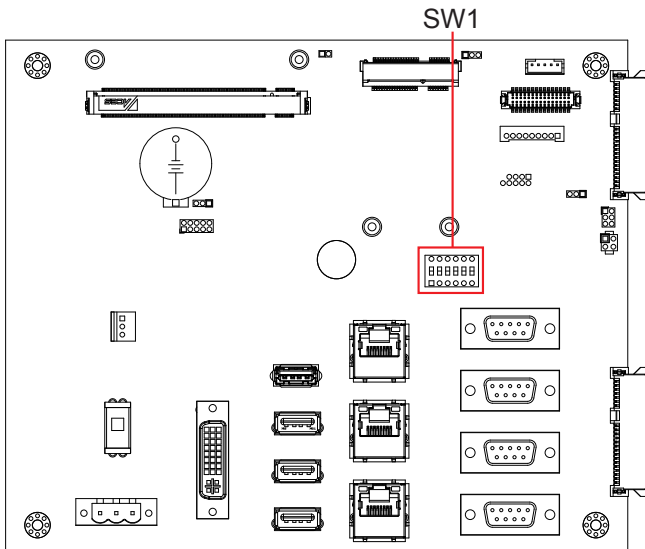

## SW2

Function: Power slide switch

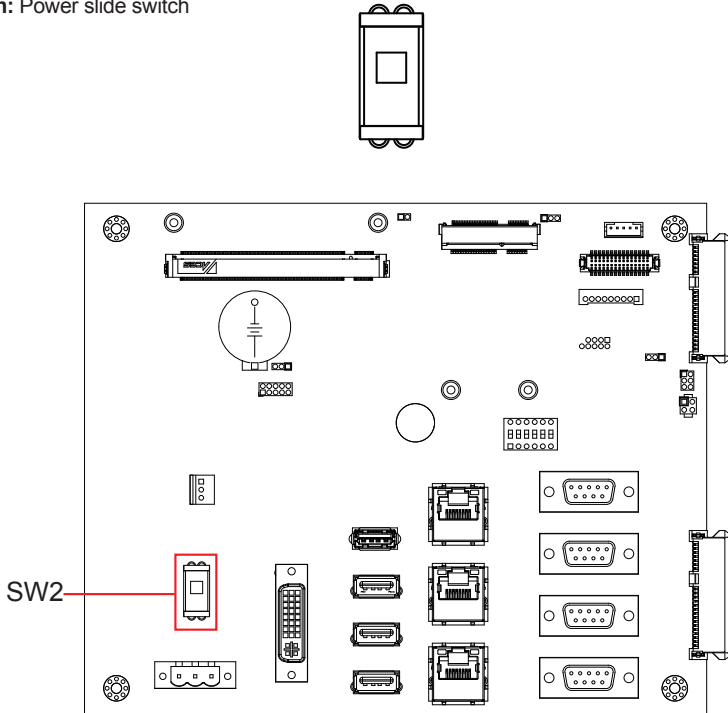



### 3.2.2. Connectors

#### PWRIN1

**Function:** power input

**Connector Type:** 5.00mm-pitch 3-pole male-type euro-style terminal block

**Setting:**

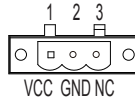

Pin	Description
1	VCC_IN 9~36V
2	GND
3	NC

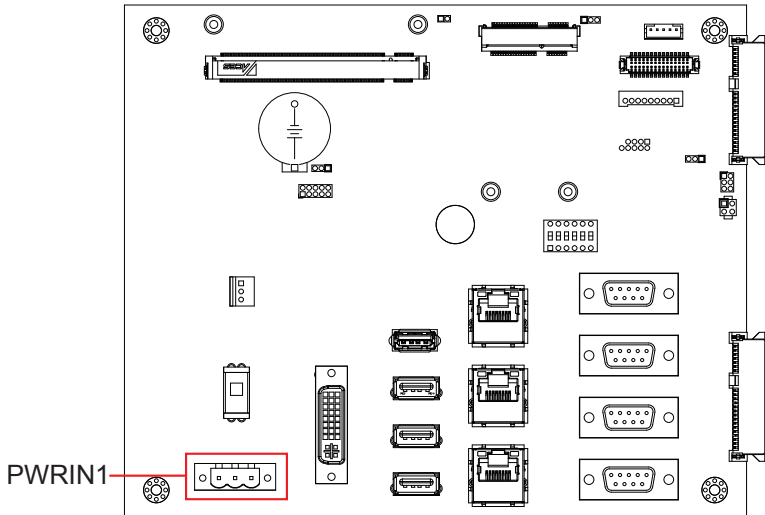

## DVI1

**Function:** DVI-I port (digital)

**Connector Type:** 29-pin DIP-type female connector

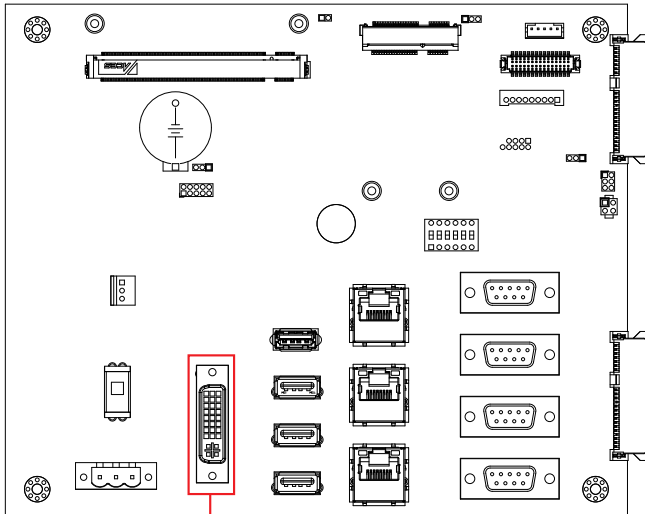
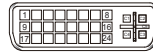

DVI1

### LAN1,2,3

**Function:** RJ-45 Ethernet connectors

**Connector Type:** 10/100/1000Mbps Fast Ethernet

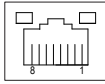

**Setting:**

Pin	Description	Pin	Description
1	MDI0	5	MDI2
2	MDI0#	6	MDI2#
3	MDI1	7	MDI3
4	MDI1#	8	MDI3#

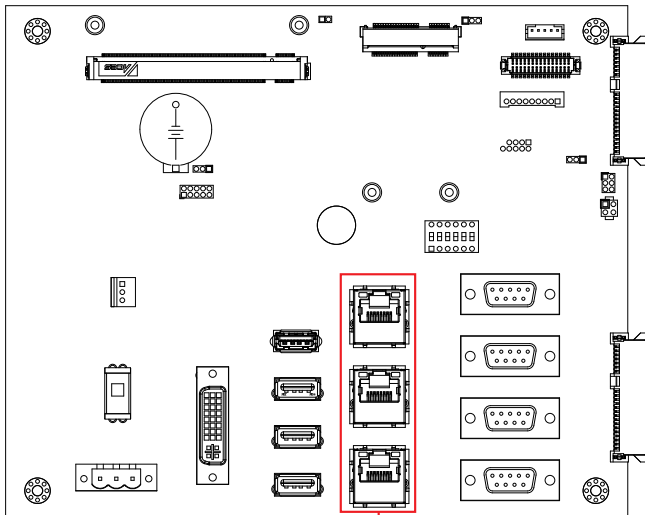

LAN1,2,3

### USB1

Function: USB2.0 pin header

Connector Type: 2.54mm-pitch 2x5-pin header

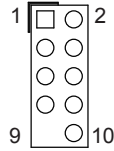

Setting:

Pin	Description	Pin	Description
1	+5V	2	+5V
3	USB D-	4	USB D-
5	USB D+	6	USB D+
7	GND	8	GND
9	GND	10	N/C(Key)

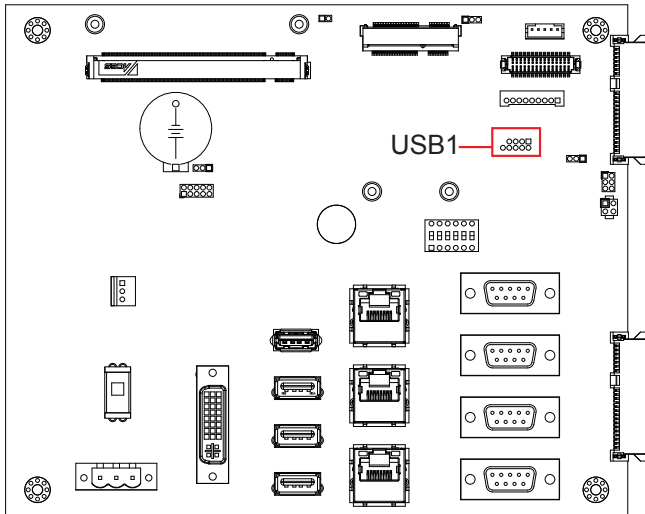

## USB2

**Function:** USB3.0 port

**Connector Type:** USB3.0 type

A connector

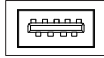

**Setting:**

Pin	Description	Pin	Description
1	VBUS	2	D-
3	D+	4	GND
5	StdA_SSRX-	6	StdA_SSRX+
7	GND	8	StdA_SSTX-
9	StdA_SSTX+		

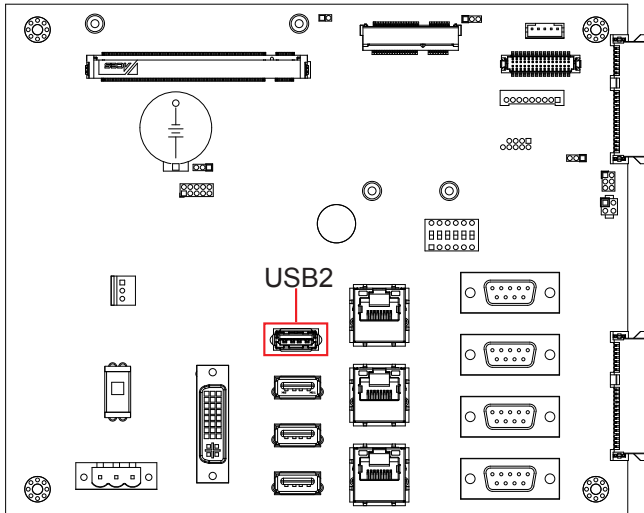

### USB3,4,5

**Function:** USB2.0 ports

**Connector Type:** USB2.0 type A connector

**Setting:**

Pin	Description
-----	-------------

1	5V
2	USB D-
3	USB D+
4	GND

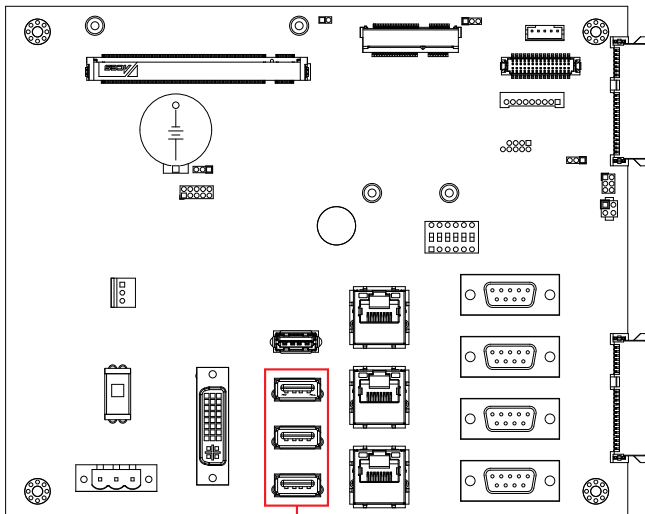
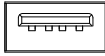

USB3  
USB4  
USB5

## P80P1

**Function:** Ext 80 port pin header

**Connector Type:** 2.00mm-pitch 2x5-pin female connector

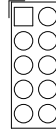

### Setting:

Pin	Description	Pin	Description
1	CK_P33M	2	GND
3	L_FRAME_N	4	L_AD0
5	P_PCIRST_N	6	N/C
7	L_AD3	8	L_AD2
9	VCC3	10	L_AD1

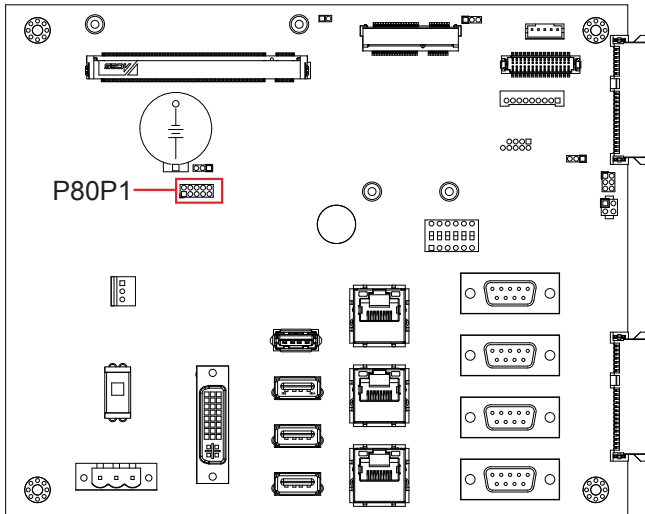

### COM1~COM4

**Function:** COM1~4

**Connector Type:** 9-pin male-type DSUB connector

**Setting:**

**RS-232**



Pin	Description	Pin	Description
1	DCD	6	DSR
2	RXD	7	RTS
3	TXD	8	CTS
4	DTR	9	RI
5	GND		

### RS-485 (COM1, COM2)

Pin	Description
1	D-
2	D+

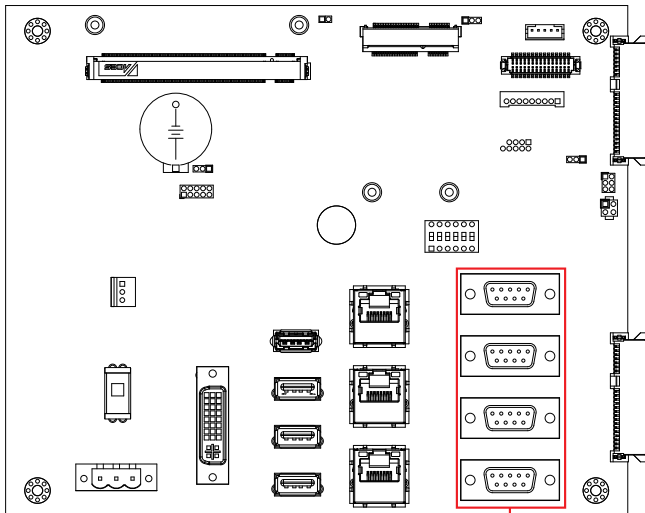

COM4  
COM3  
COM2  
COM1



## MC1

**Function:** PCI Express MiniCard socket

**Connector Type:** onboard 0.8mm pitch 52-pin edge card connector

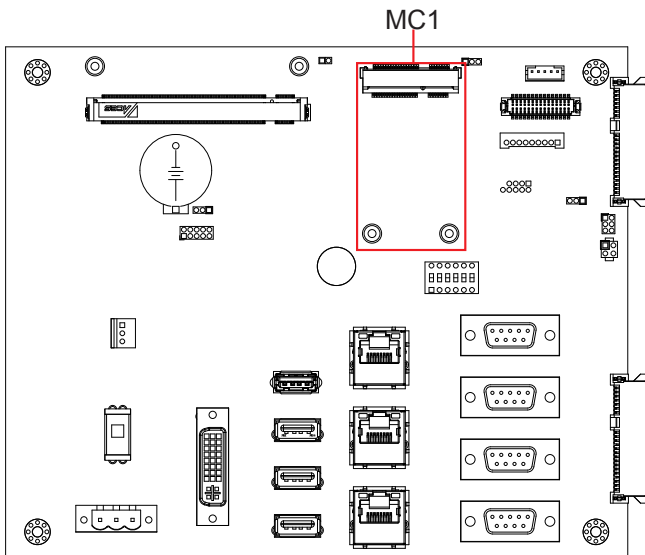
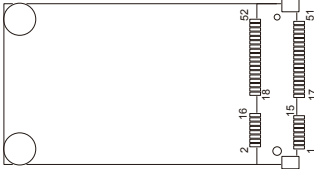

### SATA1,2

**Function:** S-ATA1 connector

**Connector Type:** SATA port with data +power vertical connector (7+15pin)

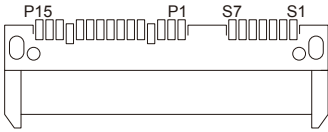

### FAN1

**Function:** CPU fan power connector

**Connector Type:** 2.54mm-pitch 1x3-pin wafer connector 

**Setting:**

Pin	Description
1	GND
2	+12V
3	NC

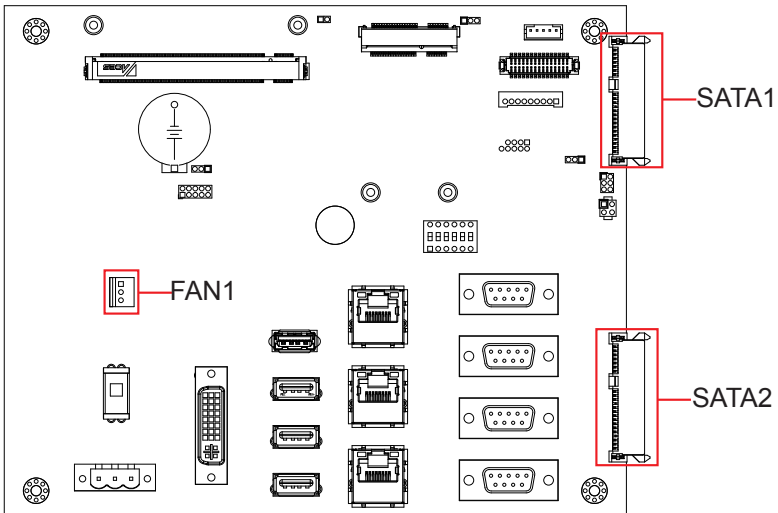

## LVDS1

**Function:** LCD connector

**Connector Type:** DF-13-30DP-1.25mm connector



### Setting:

The pin assignments conform to the industry standard.

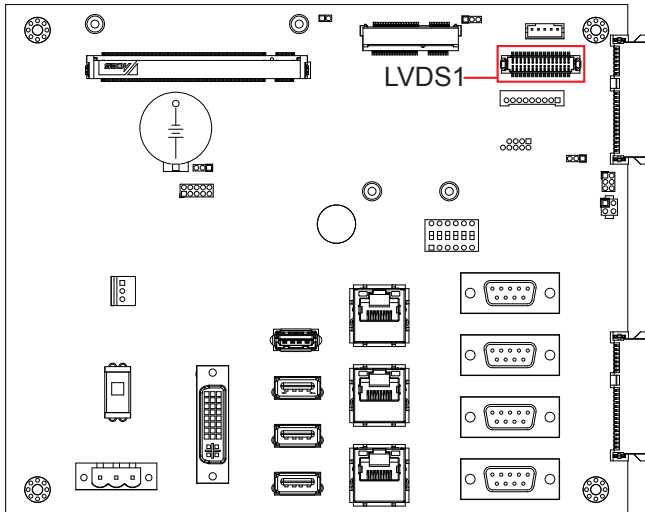

### INV1

**Function:** inverter connector

**Connector Type:** 2.00mm-pitch 1x5-pin 4-wall wafer connector

**Setting:**

Pin	Description
1	+12V/+5V
2	GND
3	BL-ON
4	BL-Control
5	GND



### JPIC1

**Function:** External PIC programming pin header

**Connector Type:** 2.00mm-pitch 2x3-pin header

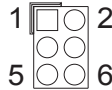

**Setting:**

Pin	Description	Pin	Description
1	NC	2	ICSP-CLK
3	ICSP-DAT	4	GND
5	VCC3	6	MCU_RST

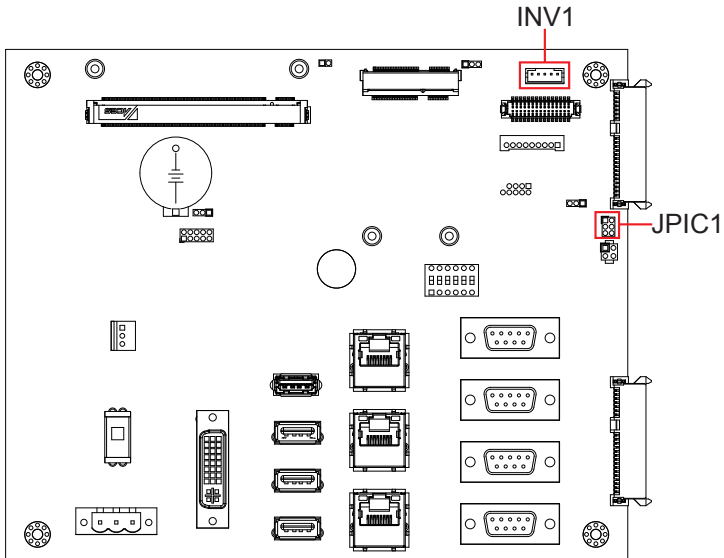

---

# Chapter 4

## Installation & Maintenance

## 4.1. Use Onboard Jumpers and Connectors

The computer's carrier board comes with some connectors to join some devices and also some jumpers to alter hardware configuration. Follow through the guide below to access these components inside the computer.

1. Loosen and remove the screws from the computer's rear side. Then, loosen and remove the screws from each of side of the computer.

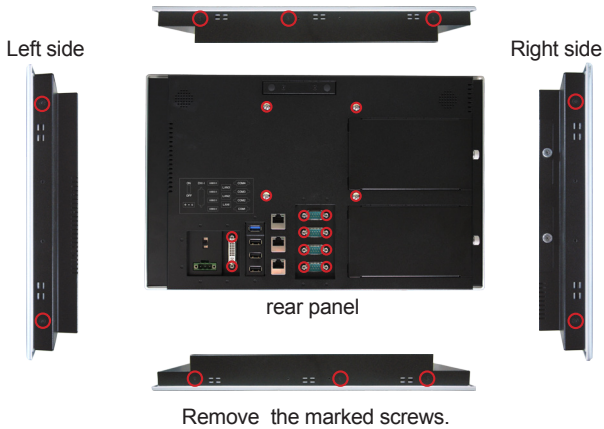

2. Dismount the rear cover from the computer. The inside of the computer comes to view.

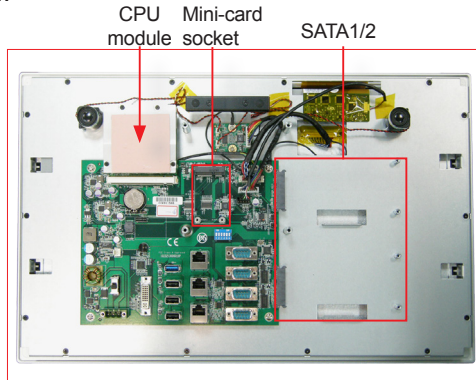

3. Adjust the jumpers or use the connectors on the carrier board as described in [3.2.1. Jumpers](#) on page [17](#) and [3.2.2. Connectors](#) on page [23](#).

## 4.2. Install Hardware

The following sections will guide you through the basic hardware installation for the computer. Remember to turn off the panel PC before installing/removing inner hardware.

### 4.2.1. Install SSD or HDD

The computer supports 2.5" HDD or SSD to work inside the computer. To install a 2.5" HDD or SSD to the computer,

1. Slide a 2.5" HDD or SSD storage device into the bracket. Fix them together by using four screws at the bracket's both sides.

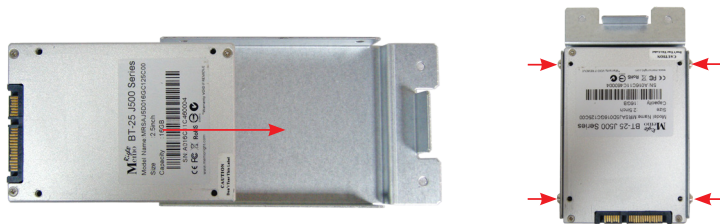

2. Loose the screw on the SATA slot cover and remove it.

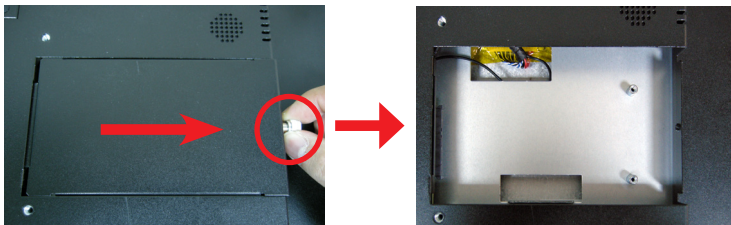

3. Slide the storage with bracket back and fix it with 2 screws.



4. Restore the SATA slot cover and tighten the screw

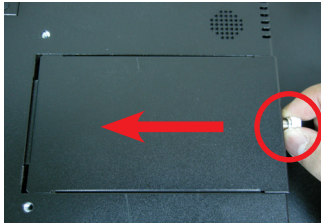



#### **4.2.2. Install Wi-Fi Module**

The computer comes with one Mini-card socket to load the computer with a wireless module of PCI Express Mini-card form factor:

- To install the Wi-Fi module, see [Appendix A: Wi-Fi Module Hardware Installation](#).

### 4.3. Mount the Computer

Integrate the computer to where it works by mounting it to a wall in the surroundings or to the rear of a display monitor. Similarly, the subsequent illustrations only take LYNC-715 for instance.

#### 4.3.1. Panel Mounting

1. Have the panel-mounting clamps included in accessory pack. Put the clamps into holes around edges of the panel PC as below.

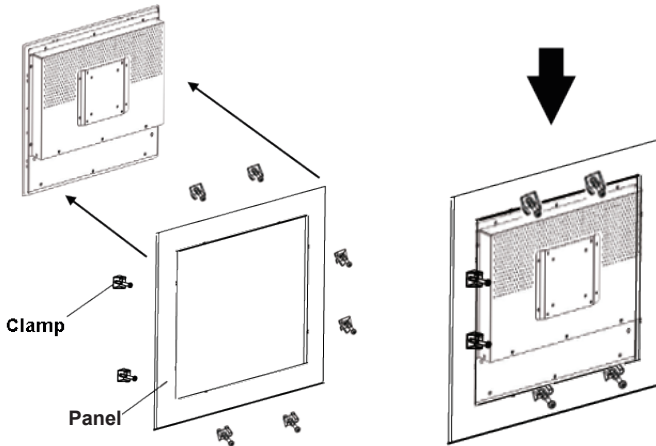

2. Put the panel PC into correct-sized frame on a wall or other devices, in this example — a transparent stand, and tightly screw panel-mounting clamps around edges.

## 4.3.2. VESA Mounting

### 4.3.2.1. Use VESA Arm

To integrate the computer to a VESA arm:

1. Find the VESA mounting holes on the Panel PC.



2. Attach the VESA arm to the rear of the computer by meeting the mounting holes on the VESA arm and VESA bracket.
3. Fix the assemblage with four screws.

VESA compliant arm

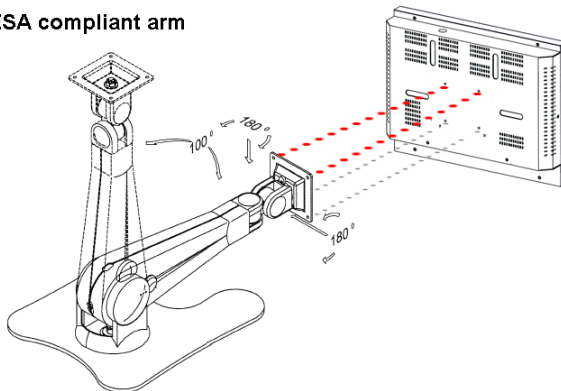

#### 4.4. Wire DC-Input Power Source



**Warning** Only trained and qualified personnel are allowed to install or replace this equipment.

Follow the instructions below to connect the computer to a DC-input power source:

1. Before wiring, make sure the power source is disconnected.
2. Find the terminal block in the accessory box.
3. Use the wire-stripping tool to strip a short insulation segment from the output wires of the DC power source.
4. Identify the positive and negative feed positions for the terminal block connection.
5. Insert the exposed wires into the terminal block plugs. Only wires with insulation should extend from the terminal block plugs. Note that the polarities between the wires and the terminal block plugs must be positive to positive and negative to negative.
6. Use a slotted screwdriver to tighten the captive screws. Plug the terminal block firmly, which wired, into the receptacle on the rear panel.

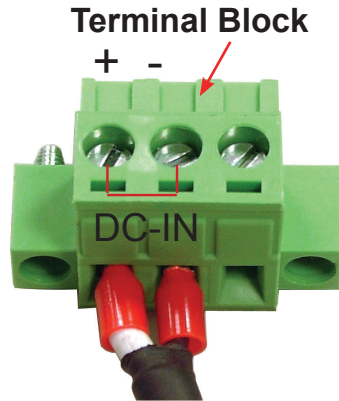
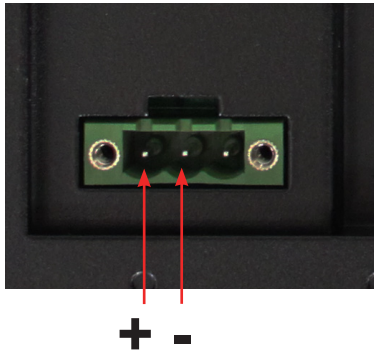

---

# Chapter 5

## BIOS

# BIOS

The BIOS Setup utility for the computer is featured by American Megatrends Inc to configure the system settings stored in the system's BIOS ROM. The BIOS is activated once the computer powers on. When the computer is off, the battery on the main board supplies power to BIOS RAM.

To enter the BIOS Setup utility, keep hitting the "Esc" key upon powering on the computer.

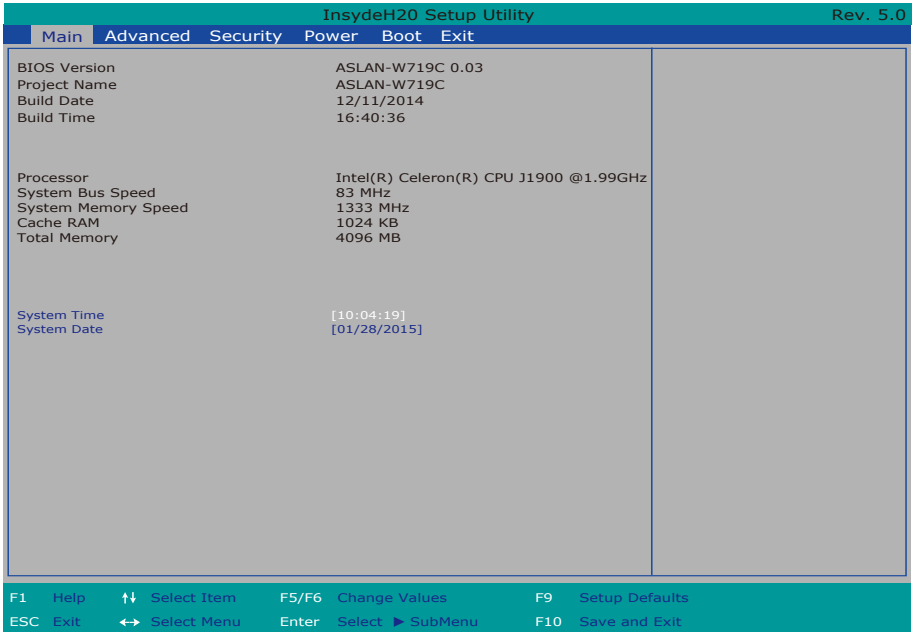

The BIOS featured menus are:

Menu	Description
Main	See <a href="#">5.1. Main</a> on page <a href="#">46</a> .
Advanced	See <a href="#">5.2. Advanced</a> on page <a href="#">47</a> .
Security	See <a href="#">5.3. Security</a> on page <a href="#">50</a>
Power	See <a href="#">5.4. Power</a> on page <a href="#">51</a>
Boot	See <a href="#">5.5. Boot</a> on page <a href="#">52</a>
Exit	See <a href="#">5.6. Exit</a> on page <a href="#">53</a> .

## Key Commands

The BIOS Setup utility relies on a keyboard to receive user's instructions. Hit the following keys to navigate within the utility and configure the utility.

Keystroke	Function
← →	Moves left/right between the top menus.
↓ ↑	Moves up/down between highlight items.
Enter	Selects an highlighted item/field.
Esc	<ul style="list-style-type: none"> <li>▶ On the top menus: Use <b>Esc</b> to quit the utility without saving changes to CMOS. (The screen will prompt a message asking you to select <b>OK</b> or <b>Cancel</b> to exit discarding changes.</li> <li>▶ On the submenus: Use <b>Esc</b> to quit current screen and return to the top menu.</li> </ul>
F5	Increases current value to the next higher value or switches between available options.
F6	Decreases current value to the next lower value or switches between available options.
F1	Opens the <b>Help</b> of the BIOS Setup utility.
F9	Restore the Setup Default (The screen then prompts a message asking you to select <b>OK</b> or <b>Cancel</b> to restore to default.)
F10	Exits the utility saving the changes that have been made. (The screen then prompts a message asking you to select <b>OK</b> or <b>Cancel</b> to exit saving changes.)

Note: Pay attention to the "WARNING" that shows at the left pane onscreen when making any change to the BIOS settings.

This BIOS Setup utility is updated from time to time to improve system performance and hence the screenshots hereinafter may not fully comply with what you actually have onscreen.

## 5.1. Main

The **Main** menu features the settings of **System Date** and **System Time** and displays some BIOS info and system info.

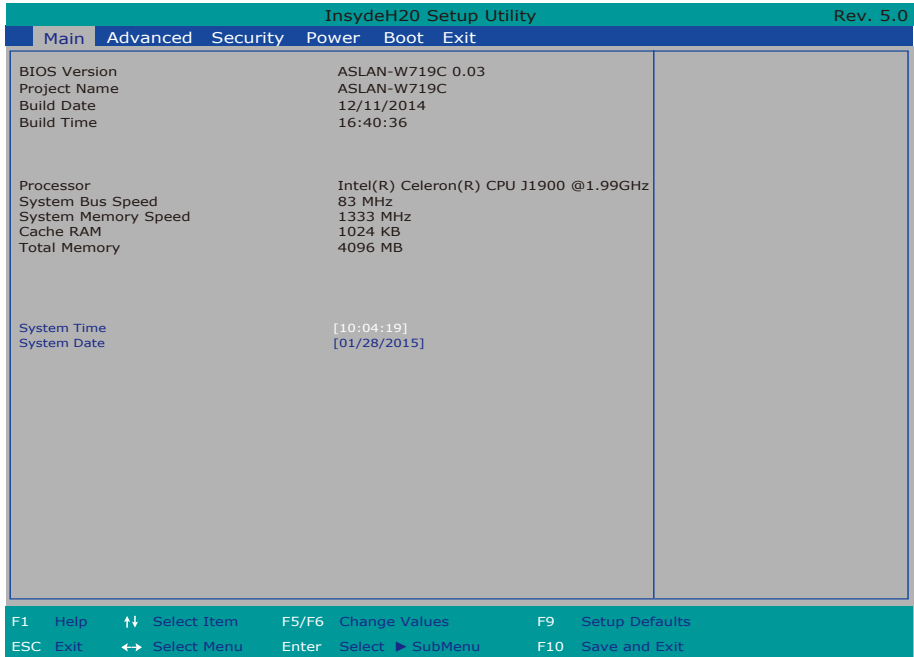

The BIOS info displayed are:

Info	Description
<b>BIOS Version</b>	Delivers the computer's BIOS version.
<b>Processor Type</b>	CPU and System BUS Information
<b>RAM info</b>	System Memory Speed, Cache RAM, Total Memory.

The featured settings are:

Setting	Description
<b>System Time</b>	Sets system time.
<b>System Date</b>	Sets system date.



## 5.2. Advanced

Access the **Advanced** menu to manage the computer's system configuration including the Super IO chip.

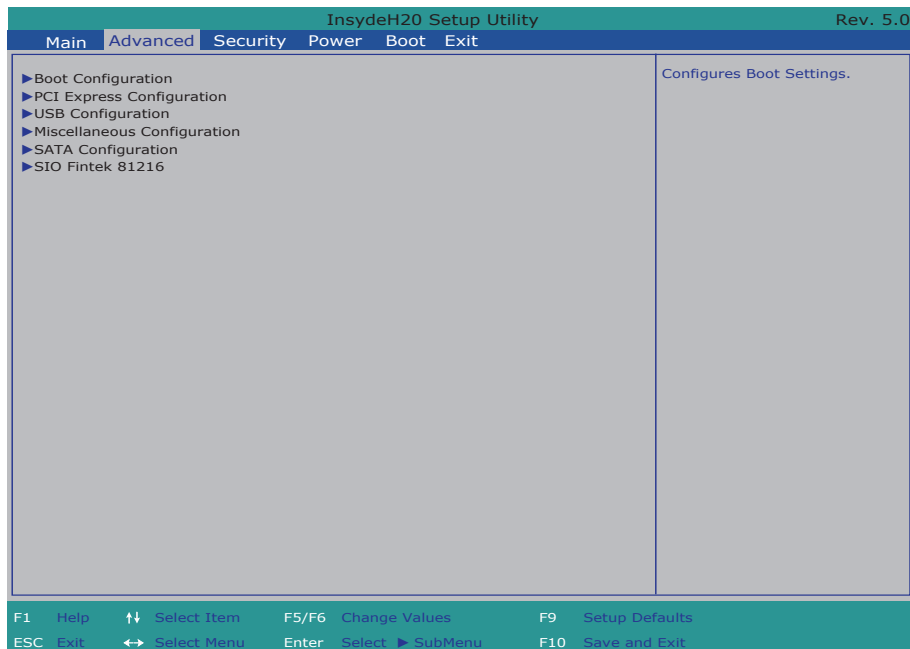

The featured settings and submenus are:

Setting	Description
Boot Configuration	See <a href="#">5.2.1. Boot Configuration</a> on page <a href="#">48</a> .
PCI Express Configuration	See <a href="#">5.2.2. PCI Express Configuration</a> on page <a href="#">48</a> .
USB Configuration	See <a href="#">5.2.3. USB Configuration</a> on page <a href="#">48</a> .
Miscellaneous Configuration	See <a href="#">5.2.4. Miscellaneous Configuration</a> on page <a href="#">49</a> .
SATA Configuration	See <a href="#">5.2.5. SATA Configuration</a> on page <a href="#">49</a> .
SIO Fintek 81216	See <a href="#">5.2.6. SIO Fintek 81216</a> on page <a href="#">49</a> .

### 5.2.1. Boot Configuration

Setting	Description
Numlock	Select Power-on state for Num lock

### 5.2.2. PCI Express Configuration

Configures PCI Express by the following settings:

Setting	Description
<b>PCI Express Root Port</b> 1/2/3/4	<ul style="list-style-type: none"> <li>▶ PCI Express Root Port Enables/disables this PCIe port.</li> <li>▶ PCIe Speed Options are: Auto, Gen 1, Gen 2 Auto is the default.</li> <li>▶ ASPM Support Options are: Disable : disables ASPM L0s : force all links to L0s state L1 : force all links to L1 state L0sL1 : force all links to L0s+L1 state Auto : BIOS auto configure</li> </ul>

### 5.2.3. USB Configuration

Select this submenu to view the status of the USB ports and configure USB features.

The featured settings are:

Setting	Description
<b>XHCI Pre-Boot Mode Support</b>	Enables/Disables XHCI Pre-Boot mode support
<b>xHCI Mode</b>	Set the mode of operation of xHCI controller Options are Disabled/Enabled/Auto/Smart Auto(default)
<b>XCHI Controller</b>	Enables/Disables XHCI controller
<b>USB2 Link Power Management</b>	Enables/Disables USB2 Link Power Management.
<b>XCHI Streams</b>	Enables/disables XHCI Stream

## 5.2.4. Miscellaneous Configuration

Setting	Description
State After G3	Set the state of System when power is re-applied after a Power failure (G3 state) Options are S0 State(default)/S5 State

## 5.2.5. SATA Configuration

Select this submenu to configure the SATA controller.

Setting	Description
SATA Controller(s)	Enables/disables the present SATA controller. ▶ <b>Enabled</b> is the default.
Chipset SATA Mode	Configures how to run the SATA drives. ▶ Options available are <b>AHCI</b> (default) and <b>IDE</b> .
Serial ATA Port 0	Delivers the SATA port Media information
Serial ATA Port 1	

## 5.2.6. SIO Fintek 81216

This submenu configures the computer's Super IO chip, Fintek F81216, for the serial port A~D.

Setting	Description
Serial Port A, B	<b>Enable</b> (default) or <b>Disable</b> Serial Port (COM)
COM Port Type	Set the mode of Serial port. Options: <b>RS232</b> (default) <b>RS485</b>
Serial Port C, D	<b>Enable</b> (default) or <b>Disable</b> Serial Port (COM)

### 5.3. Security

The **Security** menu sets up the password for the system’s supervisor account. Once the supervisor password is set up, this BIOS Setup utility is limited to access and will ask for the password each time any access is attempted.

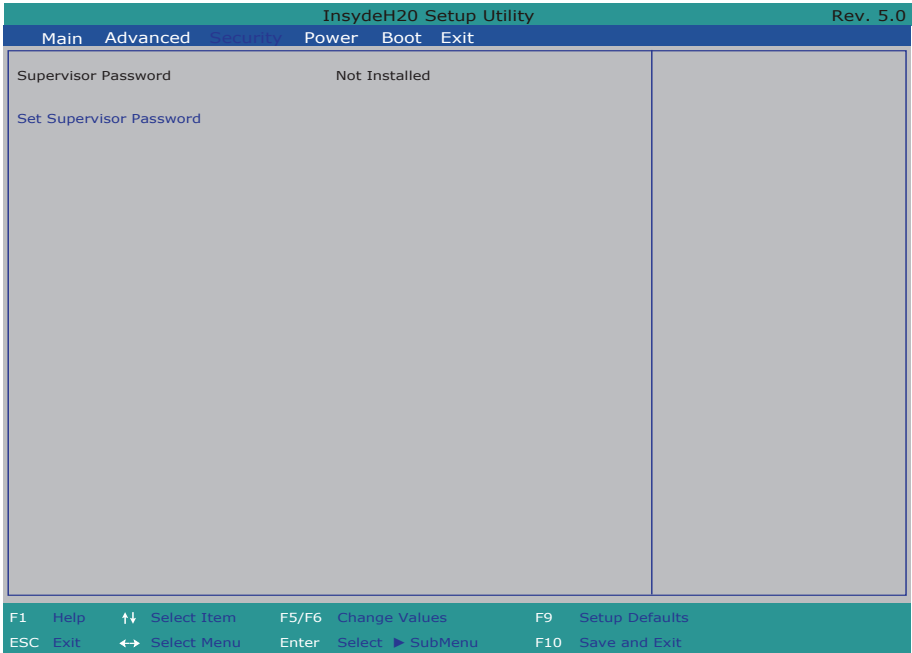

The featured setting is:

Setting	Description
<b>Set Supervisor Password</b>	<p>To set up an administrator password:</p> <ol style="list-style-type: none"> <li>1. Select <b>Set Administrator Password</b>. An <b>Set Administrator Password</b> dialog then pops up onscreen.</li> <li>2. Enter your desired password that is no less than 3 characters and no more than 20 characters.</li> <li>3. Hit [Enter] key to submit.</li> </ol>

## 5.4. Power

The Power menu sets up the power option of system

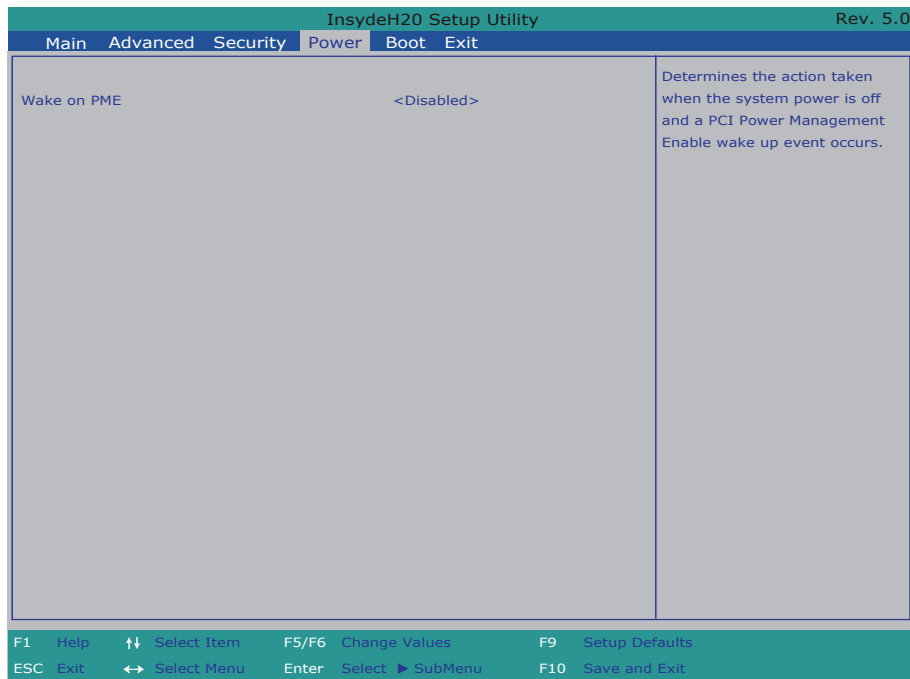

Setting	Description
<b>Wake on PME</b>	Enables or disables Wake on PME. Determines the action taken when the system power is off and a PCI Power Management Enable wake up event occurs.

## 5.5. Boot

The **Boot** menu configures how to boot up the system such as the configuration of boot device priority.

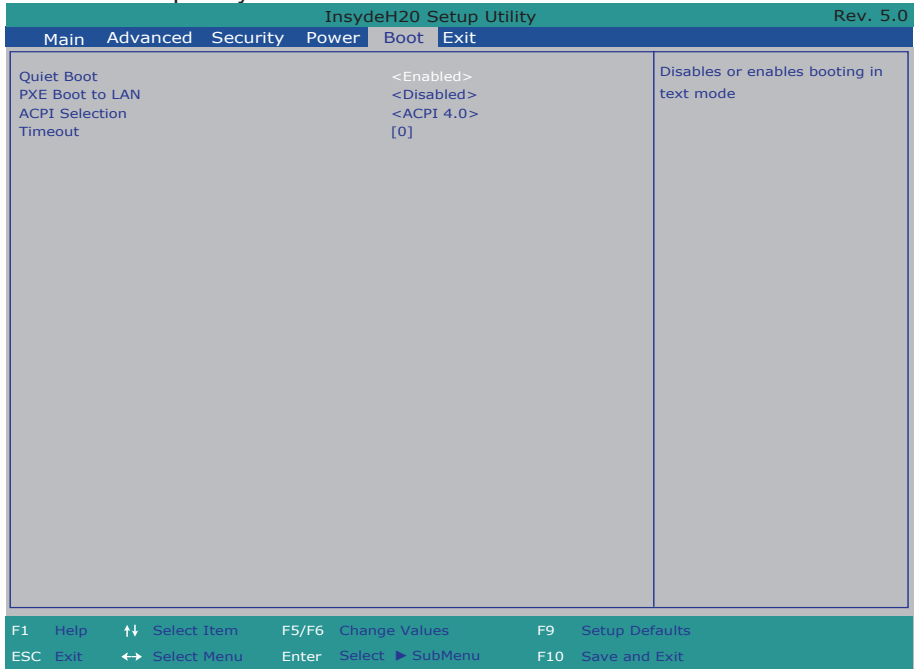

The featured settings are:

Setting	Description
<b>Quiet Boot</b>	Enables or disables booting in text mode.
<b>PXE boot to LAN</b>	Enables or disables PXE boot to LAN.
<b>APCI Selection</b>	Select boot to Acpi 3.0/Acpi 1.0B Options are Acpi 1.0B/Acpi 3.0/Acpi 4.0/Acpi 5.0
<b>Timeout</b>	Set the waiting seconds before booting the default boot selection

## 5.6. Exit

The **Exit** menu features a handful of commands to launch actions from the BIOS Setup utility regarding saving changes, quitting the utility and recovering defaults.

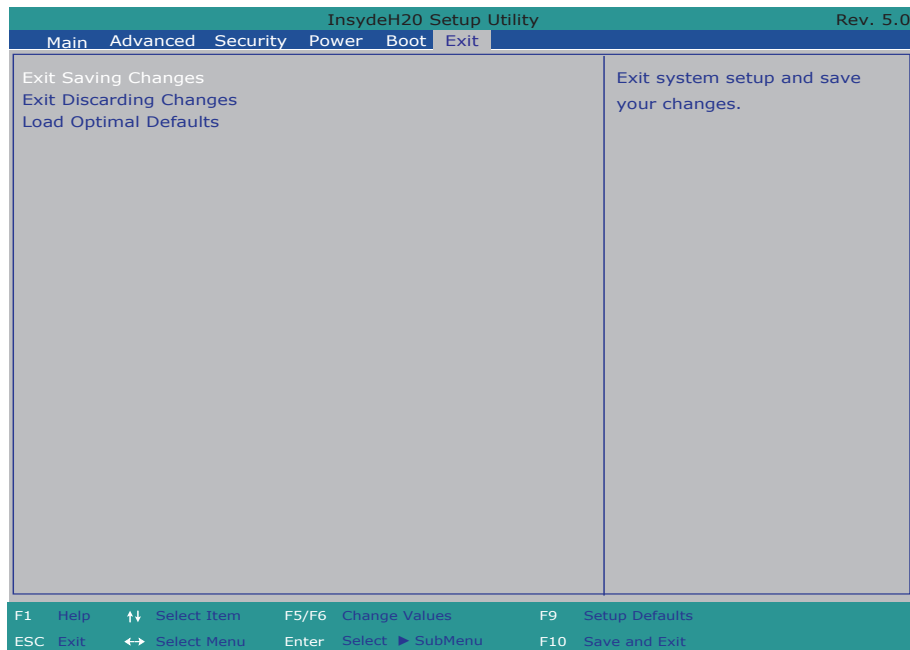

The features settings are:

Setting	Description
<b>Exit Saving Changes</b>	Exit system setup after saving the changes. ▶ Enter the item and then a dialog box pops up: <b>Exit Saving Changes?</b>
<b>Exit Discarding Changes</b>	Exit system setup without saving any changes. ▶ Enter the item and then a dialog box pops up: <b>Exit Discarding Changes?</b>
<b>Load Optimal Defaults</b>	Restore/Load Default values for all the setup options. ▶ Enter the item and then a dialog box pops up: <b>Load Optimized Defaults?</b>

---

This page is intentionally left blank.



---

# Appendices

---

## Appendix A: Wi-Fi Module Hardware Installation

To use Wi-Fi, hardware-wise the computer needs a Wi-Fi module installed, and software-wise the computer needs the device driver and an application program. This appendix will guide you to install the Wi-Fi module and the device driver. (To have a copy of the device driver, please contact ARBOR customer service by the contact info described in [Technical Support](#) on page [vi](#).)

1. Loosen and remove the screws from the computer's rear side. Then, loosen and remove the screws from each of side of the computer.

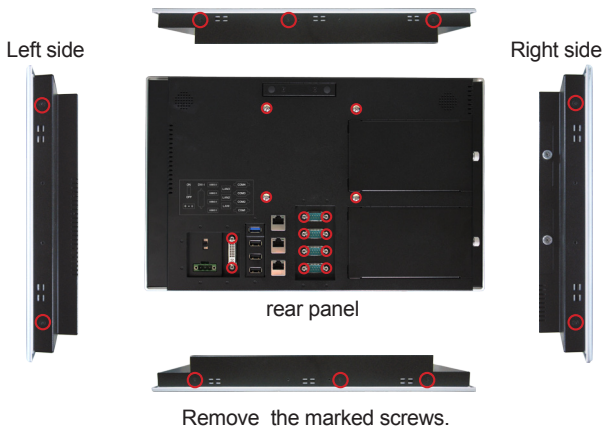

2. Dismount the rear cover from the computer. The inside of the computer comes to view.

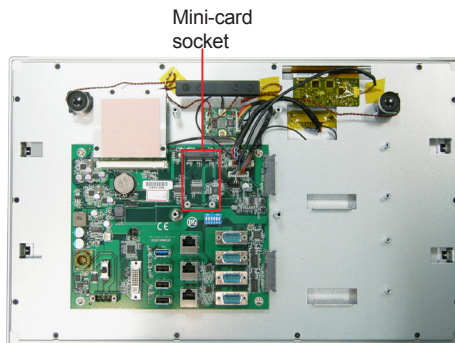

3. Prepare the Wi-Fi module kit. The module is a half-size module of PCI Express Mini-card form factor, with two U.FL connectors, one is “1”, and the other is “0”.

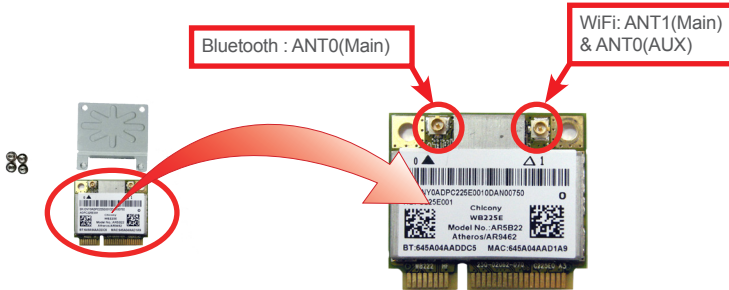

4. In order to make the half-size Wi-Fi module compatible with the Mini-card socket, extend the Wi-Fi module with a “mini half bracket”. Join them together by using two screws.



Position the WiFi module and the “mini half bracket” exactly as shown.



Join the WiFi module and the “mini half bracket” by using two screws.

5. Plug the Wi-Fi module into the Mini-card socket by a slanted angle. Fully plug the module, and note the notch on the Wi-Fi module should meet the break on the connector.

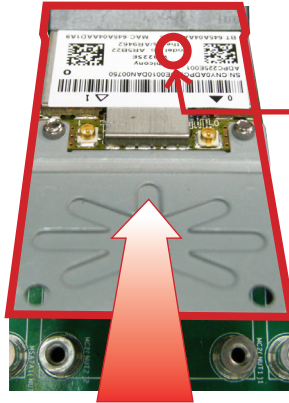

The notch on the Wi-Fi module should meet the break on the connector.

6. Press down the module and fix the module in place using two screws.



7. Connect the RF antenna's MHF connector to the Wi-Fi module's "MAIN" connector.

Connect the RF antenna's MHF connector to the Wi-Fi module's "1" connector

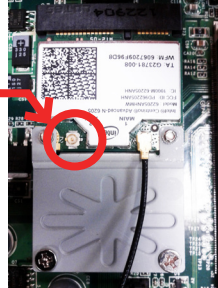

8. Loosen 2 screws on the antenna bracket to separate it from the device.



9. Remove one of the antenna plugs.



10. Pull the SMA connector through the antenna hole and mount the washer first and then the nut to the SMA connector. Make sure the nut is tightened.



11. Restore the antenna bracket and tighten 2 screws.



12. Have an external antenna. Screw and tightly fasten the antenna to the SMA connector. Swivel the antenna to an angle of best signals.



## Appendix B: Install 2nd CFast module/CFast card

1. Please take the CFast bracket, card holder and CFast module out of the package.

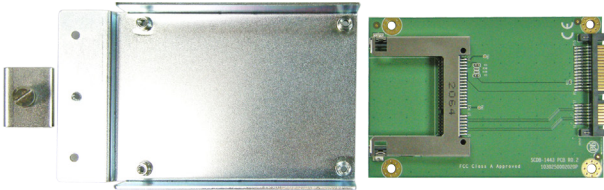

2. Loosen the screw on the SATA slot cover and remove it.

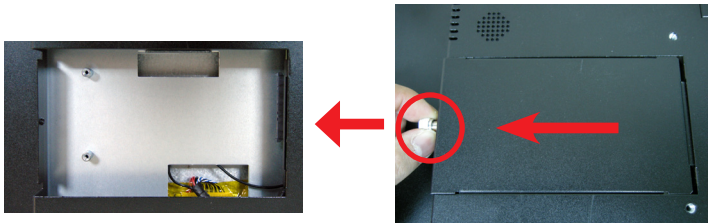

3. Fix the module and card holder on the bracket with screws

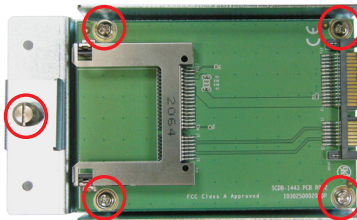

- Slide the CFast module and bracket into the slot and fix it with 2 screws.

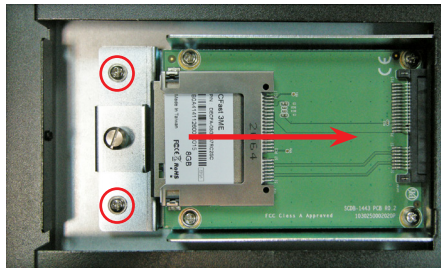

- Loose the screw to remove card holder and insert the CFast card into the slot.

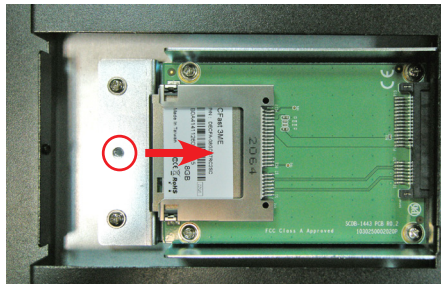

- Restore the screw to finish the process.

