

FPC-7700

Robust Box PC with 3rd Generation Intel® Core™ i7/i5/i3/Celeron® Processor Platform



Features

- Fanless Design
- Wide Range DC Power Input (9 ~36V)
- iAMT supported
- Various Video Interfaces (DVI-I + DVI-D) supported
- Optional Wi-Fi or HSUPA Wireless Connectivity supported
- Rugged Design for Shock/Vibration Protection
- Memory Support up to 16GB (DDR3)
- RAID 0,1 supported
- Intel® SSD compatible

System	
CPU	3 rd Generation Intel® Core™ i7/i5/i3 or Celeron® Processors in rPGA988 socket
Memory	2 x 204-pin DDR3 SO-DIMM sockets, supporting 1333/1600MHz SDRAM up to 16GB
Chipset	Intel® QM77
Graphics	Integrated Intel® HD 4000
ATA	2 x Serial ATA ports with 600MB/s HDD transfer rate 2 x eSATA
LAN Chipset	2 x Intel® WG82583V GbE controllers 1 x Intel® WG82579LM GbE PHY w/ iAMT
Watchdog Timer	1~255 levels reset
I/O	
Serial Port	4 x RS-232 ports via one DB-44 female connector (COM3 & COM4 are RS-232/422/485 configurable, w/ isolated protection)
USB Port	6 x USB 2.0 ports, 4 x USB 3.0/ 2.0 ports
LAN	3 x RJ-45 ports for GbE
Video Port	1 x DVI-I female connector for Digital/ Analog Video output 1 x DVI-D female connector for Digital Video output
Selectable Port	1 x DB25 connector for 1 x digital I/O, 8-in/8-out or 1 x LPT port (either one) DIO by default, can be changed to LPT
Audio	Mic-in/Line-out
Expansion Bus	1 x Mini-card socket interconnected with SIM card socket for optional Wi-Fi or HSUPA module 1 x SIM socket/1 x CFAST socket (outside accessible)

Environmental

Operating Temp.	-20 ~ 55°C (-4 ~ 131°F), ambient w/ air flow
Storage Temp.	-40 ~ 85°C (-40 ~ 185°F)
Operating Humidity	10 ~ 95% @ 55°C (non-condensing)
Vibration	3 Grms/5~500Hz/random operation w/ SSD
Shock	Operating 40G (11ms), Non-operating 60G with SSD

Qualification

Certification	CE, FCC Class A
---------------	-----------------

Power Requirement

Power Input	DC 9~36V input w/ 4-pin terminal block
Power Consumption	Max. 75W

Storage

Type	2 x 2.5" drive bays 1 x CFAST socket, can be outside accessible
------	--

Mechanical

Construction	Aluminum alloy
Mounting	Wall-mount
Weight	6.4 kg (14.1 lb)
Dimensions (W x H x D)	225 x 90 x 267 mm (8.86" x 3.54" x 10.51")

OS Support

XP Pro / W7 Pro / WS7E / WE8 STD

Ordering Information

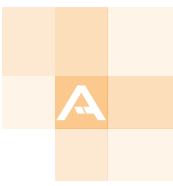

FPC-7700	Fanless system w/o expansion
----------	------------------------------



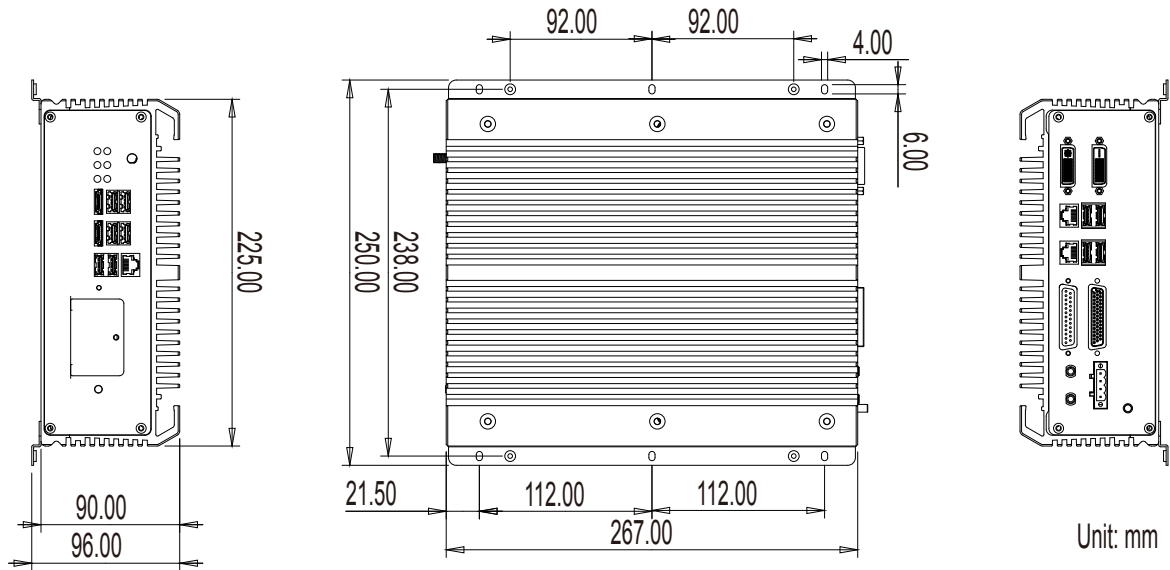



Dimensions



Optional Accessories

PAC-B120W-FSP	19V/6.32A 120W AC/DC adapter kit	
CBL-7100-COM	4 x COM ports converter cable	
WMK-7000	Wall-mount kit for FPC-7XXX Series	

Optional Configuration (CTOS* Kit)

80GB SSD	Intel® 2.5" 80GB SATAIII SSD kit	
MK-3C-4G-1	DDR3-1600 4GB SDRAM DIMM1 kit	
MK-3C-4G-2	DDR3-1600 4GB SDRAM DIMM2 kit	
MK-3C-8G-1	DDR3-1600 8GB SDRAM DIMM1 kit	
MK-3C-8G-2	DDR3-1600 8GB SDRAM DIMM2 kit	
HSPA-SI1400	HSUPA 3.75G module kit & internal wiring	
WiFi-AT2300	Atheros AR9462 Wi-Fi module w/ 20cm internal wiring	
ANT-H11	1 x 2dBi HSUPA antenna	
ANT-D11	1 x Wi-Fi dual-band 2.4G/5G antenna	
Core™ i3-3120ME	3 rd Generation Intel® Core™ i3-3120ME, L2/3M, 2.4G	
Core™ i5-3610ME	3 rd Generation Intel® Core™ i5-3610ME, L2/3M, 2.7G	
Core™ i7-3610QE	3 rd Generation Intel® Core™ i7-3610QE, L2/6M, 2.3G	



*CTOS means Configure-to-Order Service.