

---

# TOKIN Series

Fanless Industrial Panel PC  
with  
Intel® Celeron® 827E / Atom™ D2550

## User's Manual

Version 1.1

---

This page is intentionally left blank.

---

---

## Revision History

Version	Date	Description
1.0	October 2012	Initial release
1.1	February 2014	This revision is issued due to the following change in this user's manual: <ul style="list-style-type: none"><li>▶ <a href="#">3.6. Wire DC-Input Power Source</a></li><li>▶ Combine Celeron and Atom models into one manual</li></ul>

---

This page is intentionally left blank.

Revision History .....	i
Contents .....	iii
Preface.....	v
<b>Chapter 1 - General Information.....</b>	<b>1</b>
1.1. Introduction .....	2
1.2. Packing List .....	2
1.3. Ordering Information .....	3
1.4. CD Driver Paths.....	4
1.5. Specifications.....	6
1.6. Locating Controls and Connectors .....	8
1.7. Dimensions.....	12
<b>Chapter 2 - Engine of the IPPC.....</b>	<b>16</b>
2.1. Board Layout.....	17
2.2. Jumpers and Connectors.....	18
2.2.1. Jumpers & Connectors List .....	18
2.2.2. Jumper Settings .....	19
2.2.3. DIP Switch Settings .....	20
2.2.4. Connector Pin Assignments .....	21
<b>Chapter 3 - Installation and Maintenance.....</b>	<b>24</b>
3.1. Install SSD, PCIe, PCI and Mini-card .....	25
3.1.1. Remove the Rear Panel .....	25
3.1.2. Install SSD .....	26
3.1.3. Install PCI Card.....	29
3.1.4. Install PCIe Card.....	30
3.1.5. Install Mini-card.....	31
3.2. Install/Uninstall CFast Card .....	32
3.3. Install Internal USB Drive .....	34
3.4. Panel Mounting .....	37
3.4.1. Panel Mounting with Clamps .....	37
3.4.2. Panel Mounting with Brackets.....	38
3.5. VESA Arm Mounting .....	40
3.6. Wire DC-Input Power Source .....	41
<b>Chapter 4 - Driver &amp; AP .....</b>	<b>44</b>
4.1. Before Installation.....	45
4.2. Drivers.....	47
4.2.1. CHIPSET.....	47
4.2.2. Framework 3.5.....	51
4.2.3. VGA .....	53
4.2.4. LAN.....	59
4.2.5. TOUCH .....	63
4.2.6. AHCI (Advanced Host Controller Interface).....	65

- Chapter 5 - BIOS ..... 69**
  - 5.1. Main ..... 72**
  - 5.2. Advanced ..... 74**
    - 5.2.1. ACPI Settings..... 75**
    - 5.2.2. CPU Configuration ..... 76**
    - 5.2.3. SATA Configuration ..... 76**
    - 5.2.4. USB Configuration ..... 76**
    - 5.2.5. H/W Monitor ..... 77**
    - 5.2.6. Super IO Configuration..... 77**
    - 5.2.7. Second Super IO Configuration..... 77**
  - 5.3. Chipset ..... 79**
    - 5.3.1. System Agent (SA) Configuration ..... 80**
    - 5.3.2. PCH-IO Configuration ..... 85**
    - 5.3.3. Host Bridge..... 86**
    - 5.3.4. South Bridge..... 88**
  - 5.4. Boot ..... 90**
  - 5.5. Security ..... 92**
  - 5.6. Save & Exit..... 94**
- Appendix ..... 96**
  - 1. PenMount Monitor..... 97**
  - 2. PenMount Control Panel ..... 98**

## Copyright Notice

All Rights Reserved.

The information in this document is subject to change without prior notice in order to improve the reliability, design and function. It does not represent a commitment on the part of the manufacturer.

Under no circumstances will the manufacturer be liable for any direct, indirect, special, incidental, or consequential damages arising from the use or inability to use the product or documentation, even if advised of the possibility of such damages.

This document contains proprietary information protected by copyright. All rights are reserved. No part of this document may be reproduced by any mechanical, electronic, or other means in any form without prior written permission of the manufacturer.

## Declaration of Conformity

### CE

The CE symbol on your product indicates that it is in compliance with the directives of the Union European (EU). A Certificate of Compliance is available by contacting Technical Support.

This product has passed the CE test for environmental specifications when shielded cables are used for external wiring. We recommend the use of shielded cables. This kind of cable is available from ARBOR. Please contact your local supplier for ordering information.

### Warning

This is a class A product. In a domestic environment this product may cause radio interference in which case the user may be required to take adequate measures.

## FCC Class A

This device complies with Part 15 of the FCC Rules. Operation is subject to the following two conditions:

- (1) This device may not cause harmful interference, and
- (2) This device must accept any interference received, including interference that may cause undesired operation.

### NOTE:

This equipment has been tested and found to comply with the limits for a Class A digital device, pursuant to Part 15 of the FCC Rules. These limits are designed to provide reasonable protection against harmful interference when the equipment is operated in a commercial environment. This equipment generates,

uses, and can radiate radio frequency energy and, if not installed and used in accordance with the instruction manual, may cause harmful interference to radio communications. Operation of this equipment in a residential area is likely to cause harmful interference in which case the user will be required to correct the interference at his own expense.

### **RoHS**

ARBOR Technology Corp. certifies that all components in its products are in compliance and conform to the European Union's Restriction of Use of Hazardous Substances in Electrical and Electronic Equipment (RoHS) Directive 2002/95/EC.

The above mentioned directive was published on 2/13/2003. The main purpose of the directive is to prohibit the use of lead, mercury, cadmium, hexavalent chromium, polybrominated biphenyls (PBB), and polybrominated diphenyl ethers (PBDE) in electrical and electronic products. Member states of the EU are to enforce by 7/1/2006.

ARBOR Technology Corp. hereby states that the listed products do not contain unintentional additions of lead, mercury, hex chrome, PBB or PBDB that exceed a maximum concentration value of 0.1% by weight or for cadmium exceed 0.01% by weight, per homogenous material. Homogenous material is defined as a substance or mixture of substances with uniform composition (such as solders, resins, plating, etc.). Lead-free solder is used for all terminations (Sn(96-96.5%), Ag(3.0-3.5%) and Cu(0.5%)).

### **SVHC / REACH**

To minimize the environmental impact and take more responsibility to the earth we live, Arbor hereby confirms all products comply with the restriction of SVHC (Substances of Very High Concern) in (EC) 1907/2006 (REACH --Registration, Evaluation, Authorization, and Restriction of Chemicals) regulated by the European Union.

All substances listed in SVHC < 0.1 % by weight (1000 ppm)

### **Important Safety Instructions**

Read these safety instructions carefully:

1. Read all cautions and warnings on the equipment.
2. Place this equipment on a reliable surface when installing. Dropping it or letting it fall may cause damage
3. Make sure the correct voltage is connected to the equipment.
4. For pluggable equipment, the socket outlet should be near the equipment and should be easily accessible.
5. Keep this equipment away from humidity.



6. The openings on the enclosure are for air convection and protect the equipment from overheating. **DO NOT COVER THE OPENINGS.**
7. Position the power cord so that people cannot step on it. Do not place anything over the power cord.
8. Never pour any liquid into opening. This may cause fire or electrical shock.
9. Never open the equipment. For safety reasons, the equipment should be opened only by qualified service personnel.
10. If one of the following situations arises, get the equipment checked by service personnel:
  - a. The power cord or plug is damaged.
  - b. Liquid has penetrated into the equipment.
  - c. The equipment has been exposed to moisture.
  - d. The equipment does not work well, or you cannot get it to work according to the user's manual.
  - e. The equipment has been dropped or damaged.
  - f. The equipment has obvious signs of breakage.
11. Keep this User's Manual for later reference.

### **About This Manual**

This User's Manual is intended for experienced users and integrators with hardware knowledge of personal computers. If you are not sure about any description in this User's Manual, please consult your vendor before further handling.

### **Warning**

The Industrial PC and its components contain very delicately Integrated Circuits (IC). To protect the Industrial PC and its components against damage caused by static electricity, you should always follow the precautions below when handling it:

1. Disconnect your Industrial PC from the power source when you want to work on the inside.
2. Use a grounded wrist strap when handling computer components.
3. Place components on a grounded antistatic pad or on the bag that came with the Industrial PC, whenever components are separated from the system.

### **Replacing the Lithium Battery**

Incorrect replacement of the lithium battery may lead to a risk of explosion.

The lithium battery must be replaced with an identical battery or a battery type recommended by the manufacturer.

Do not throw lithium batteries into the trash can. It must be disposed of in accordance with local regulations concerning special waste.

### **Technical Support**

If you have any technical difficulties, please consult the user's manual first at:

<ftp://ftp.arbor.com.tw/pub/manual>

Please do not hesitate to call or e-mail our customer service when you still cannot find out the answer.

<http://www.arbor.com.tw>

E-mail: [info@arbor.com.tw](mailto:info@arbor.com.tw)

### **Warranty**

This product is warranted to be in good working order for a period of one year from the date of purchase. Should this product fail to be in good working order at any time during this period, we will, at our option, replace or repair it at no additional charge except as set forth in the following terms. This warranty does not apply to products damaged by misuse, modifications, accident or disaster.

Vendor assumes no liability for any damages, lost profits, lost savings or any other incidental or consequential damage resulting from the use, misuse of, or inability to use this product. Vendor will not be liable for any claim made by any other related party.

Vendors disclaim all other warranties, either expressed or implied, including but not limited to implied warranties of merchantability and fitness for a particular purpose, with respect to the hardware, the accompanying product's manual(s) and written materials, and any accompanying hardware. This limited warranty gives you specific legal rights.

Return authorization must be obtained from the vendor before returned merchandise will be accepted. Authorization can be obtained by calling or faxing the vendor and requesting a Return Merchandise Authorization (RMA) number. Returned goods should always be accompanied by a clear problem description.

---

# Chapter 1

## General Information

## 1.1. Introduction

The TOKIN industrial panel PC is a work of the state-of-the-art HMI. The IPPC comes with 8-, 12-, and 15-inch models loaded with Intel® Celeron® 827E / Atom D2550 processor and Intel® chipset to deliver the high performance for industrial computing. Working with particular software, the panel PC can deliver some industrial applications such as kiosk or factory automation.

The IPPC is highly protected against extreme shock and vibration. It dissipates heat by fan-less thermal conduction and runs on very low power. This makes the system highly reliable and inexpensive to maintain and therefore the best choice for industrial automation.

## 1.2. Packing List

Carefully inspect the contents in the package, which should contain the items listed hereunder. If any item is missing or appears damaged, contact your local dealer or distributor.

TOKIN-6083    TOKIN-6123    TOKIN-6153



1 x TOKIN series Industrial Panel PC (TOKIN-6083, TOKIN-6123 or TOKIN-6153)



1 x Accessory Box that contains the following items:

- Driver CD
- User's Manual
- Screws/Cable
- 3-pin plug for terminal block
- 2.5" HDD/SSD bracket
- PCIe x 1 riser card

### 1.3. Ordering Information

TOKIN-6083-827E	8" Intel® Celeron® 827E industrial panel PC
TOKIN-6123-827E	12" Intel® Celeron® 827E industrial panel PC
TOKIN-6153-827E	15" Intel® Celeron® 827E industrial panel PC
TOKIN-6083-D2550	8" Intel® Atom™ D2550 industrial panel PC
TOKIN-6123-D2550	12" Intel® Atom™ D2550 industrial panel PC
TOKIN-6153-D2550	15" Intel® Atom™ D2550 industrial panel PC

The following items are normally optional, but some vendors may include them as a standard package, or some vendors may not carry all the items.

#### Optional Accessories



PAC-P065W  
65W AC/DC power adapter kit

PAC-P120W-FSP  
120W AC/DC power adapter kit

#### Optional Configuration (Configure-to-Order Service)



SSD-80G  
Intel® 2.5" 80GB SATAIII SSD kit



MM-3C-2G / MM-3C-4G  
DDR3-1333 2GB/4GB SDRAM



WIFI-IN1350  
802.11 a/b/g/n WiFi module kit & internal wiring



ANT-D11  
1 x WiFi Dual-band 2.4G/5G antenna

## 1.4. CD Driver Paths

Find the drivers on CD for each Windows XP and Windows 7 operating system.

For Models with Intel® Celeron® 827E processor :

### Windows XP

Driver & AP	Path
Chipset	\Chipset
Framework 3.5	\NET Framework 3.5
VGA	\Graphic\WinXP\x64
	\Graphic\WinXP\x86
LAN	\LAN\17.1\WinXP
Touch	\Touch\PenMount Windows Universal Driver V2.2.0.283. (Win7_32_64bit_WHQL)

### Windows 7

Driver & AP	Path
Chipset	\Chipset
Framework 3.5	\NET Framework 3.5
VGA	\Graphic\Win7\x64
	\Graphic\Win7\x86
LAN	\LAN\17.1\Win7
Touch	\Touch\PenMount Windows Universal Driver V2.2.0.283. (Win7_32_64bit_WHQL)

For Models with Intel® Atom™ D2550 processor :

### Windows XP

Driver & AP	Path
Chipset	\CHIPSET\Win_x86 \CHIPSET\Win_x64
.NET Framework 3.5	\NET Framework 3.5
VGA	\GRAPHIC\WIN XP\Utilities
LAN	\LAN\WinXP
Touch	\TOUCH\PenMount Windows Universal Driver V2.2.0.283. (Win7_32_64bit_WHQL)
AHCI	\AHCI

### Windows 7

Driver & AP	Path
Chipset	\CHIPSET\Win_x86 \CHIPSET\Win_x64
.NET Framework 3.5	\NET Framework 3.5
VGA	\GRAPHIC\WIN 7
LAN	\LAN\Win7
Touch	\TOUCH\PenMount Windows Universal Driver V2.2.0.283. (Win7_32_64bit_WHQL)
AHCI	\AHCI

## 1.5. Specifications

<b>System Kernel</b>	
Processor	Intel® Celeron® 827E 1.4GHz processor
	Intel® Atom™ D2550 1.86GHz processor
Chipset	Intel® HM65 for Intel® Celeron® 827E
	Intel® PCH NM10 for Intel® Atom™ D2550
System Memory	2 x DDR3 SO-DIMM Sockets, supporting 1333/1066 MHz SDRAM up to 8GB for Intel® Celeron® 827E
	1 x DDR3 SO-DIMM socket, supporting 1066/800 MHz SDRAM up to 4GB for Intel® Atom™ D2550
LAN Chipset	2 x Gigabit Ethernet controllers
Watchdog Timer	1 ~ 255 levels reset
<b>I/O Ports</b>	
Serial Ports	2 x RS-232 and 2 x isolated RS-232/485 ports, all are DB-9 type
USB Ports	4 x Type-A USB 2.0 ports
LAN Ports	2 x RJ-45 Gigabit Ethernet ports
DVI	1 x DVI-I connector
WiFi	2 x SMA antenna holes for optional WiFi function
Optional Port	1 x semi-piercing D-sub hole reserved for users' internal wiring
<b>Storage</b>	
Type 1	1 x outside accessible Primary CFAST slot
Type 2	1 x outside accessible 2nd CFAST slot (default) or 2.5" Drive Bay (included in Standard Accessories)
<b>Qualification</b>	
Certification	CE, FCC Class A
<b>Environment</b>	
Operating Temp.	-20 ~ 60°C (-4 ~ 140°F)
Storage Temp.	-20 ~ 70°C (-4 ~ 158°F)
Operating Humidity	0 ~ 95% RH @40°C (non-condensing)
Vibration	5 ~ 500Hz, 2Grms Random (with CF/SSD)
Shock	Operating 15G, 11ms & Non-operating 40G, 11ms (with CF/SSD)
<b>Mechanical</b>	
Mounting Type	Panel Mount and VESA-75/100 Mount



Chassis	Panel-mounting chassis, Aluminum Front Bezel and SECC steel chassis
Dimension (W x D x H)	274.96 x 77.0 x 207.96 mm (10.82" x 3.03" x 8.18") for TOKIN-6083
	325.86 x 77.0 x 258.86 mm (12.82" x 3.03" x 10.18") for TOKIN-6123
	389.93 x 84.3 x 309.93 mm (15.35" x 3.31" x 12.20") for TOKIN-6153
Weight (Net)	4.5 kg (9.92 lb) for TOKIN-6083
	5.6 kg (12.34 lb) for TOKIN-6123
	7 kg (15.43 lb) for TOKIN-6153
<b>LCD Display</b>	
Size/Type	8" TFT LCD Panel for TOKIN-6083 12" TFT LCD Panel for TOKIN-6123 15" TFT LCD Panel for TOKIN-6153
Max. Resolution	1024 x 768, XGA
Max. Colors	16.2M
Luminance	300 cd/m <sup>2</sup> for TOKIN-6083 and TOKIN-6153; 500 cd/m <sup>2</sup> for TOKIN-6123
Touch Screen	5-wire, Analog Resistive
Function Key	Brightness up/down, Screen on/off
Status LED	Power-on LED
<b>Internal Sockets &amp; Connectors</b>	
CF Type	1 x CFast outside accessible push-pull socket
Expansion Slot	2 x Mini-Card sockets
	1 x PCI 32-bit slot (default) or 1 x PCI Express (included in Standard Accessories)
Optional	1 x semi-piercing D-sub hole reserved for field-bus card
<b>Power System</b>	
Power Input	DC 9~36V

## 1.6. Locating Controls and Connectors

### Front View of TOKIN-6153

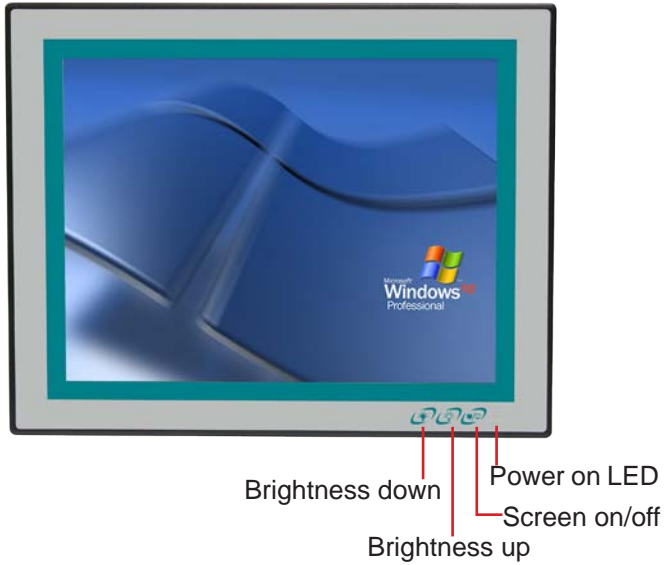

### Front View of TOKIN-6123



**Front View of TOKIN-6083**



**Rear View of TOKIN-6153**



**Rear View of TOKIN-6123**

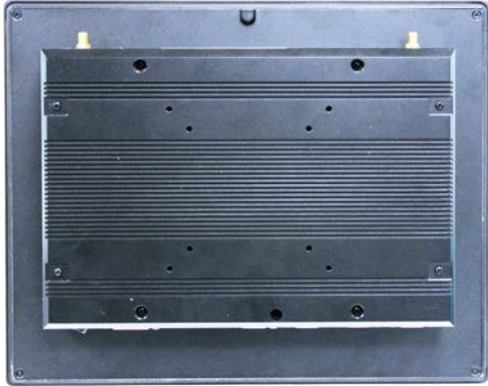

**Rear View of TOKIN-6083**



**Bottom View of TOKIN-6153**

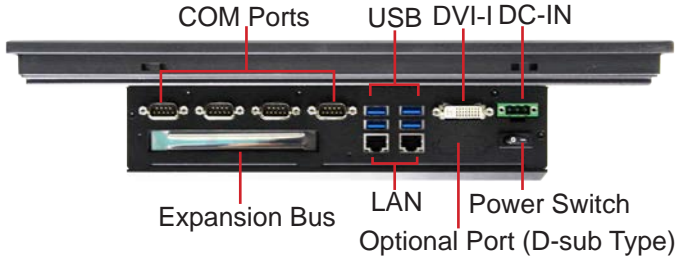

**Bottom View of TOKIN-6123**



**Bottom View of TOKIN-6083**



## 1.7. Dimensions

### TOKIN-6153

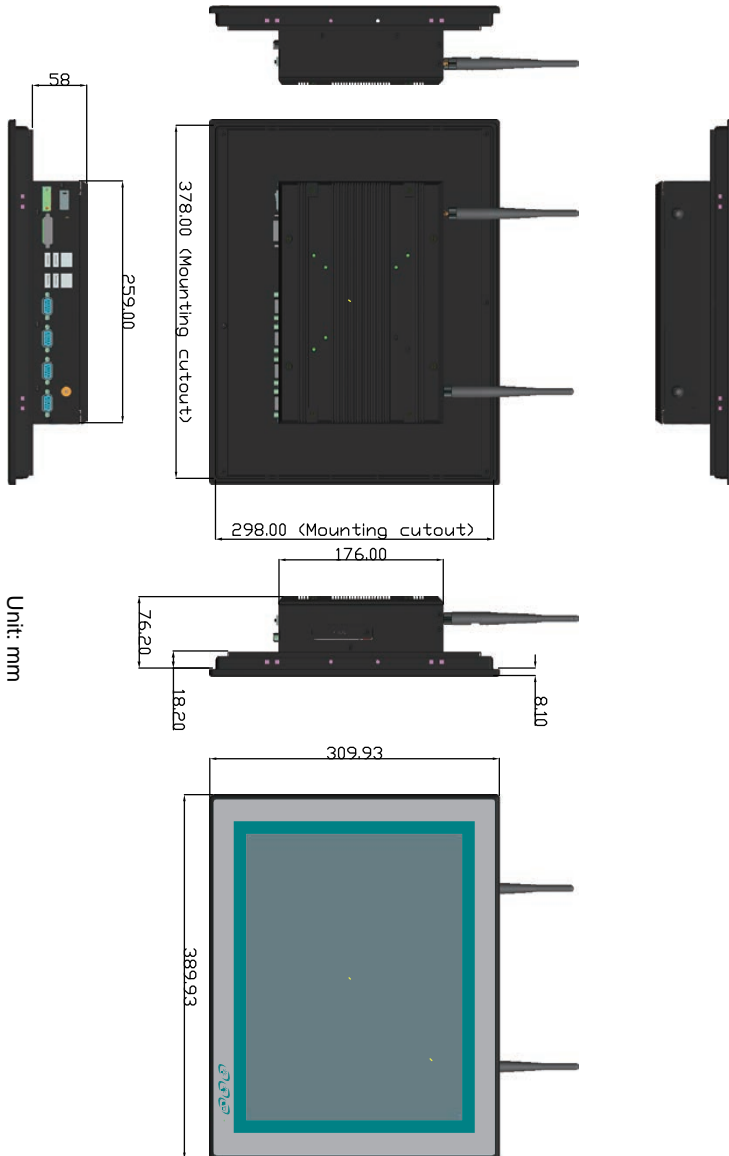

TOKIN-6123

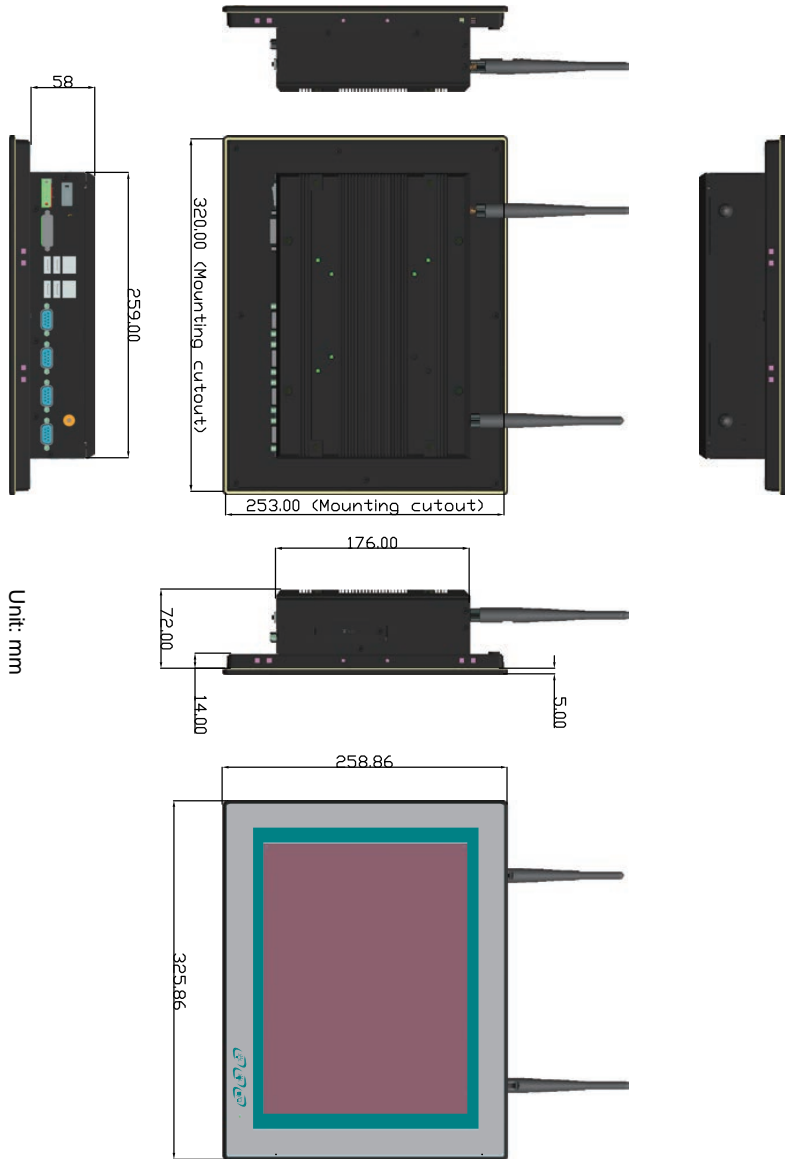

TOKIN-6083

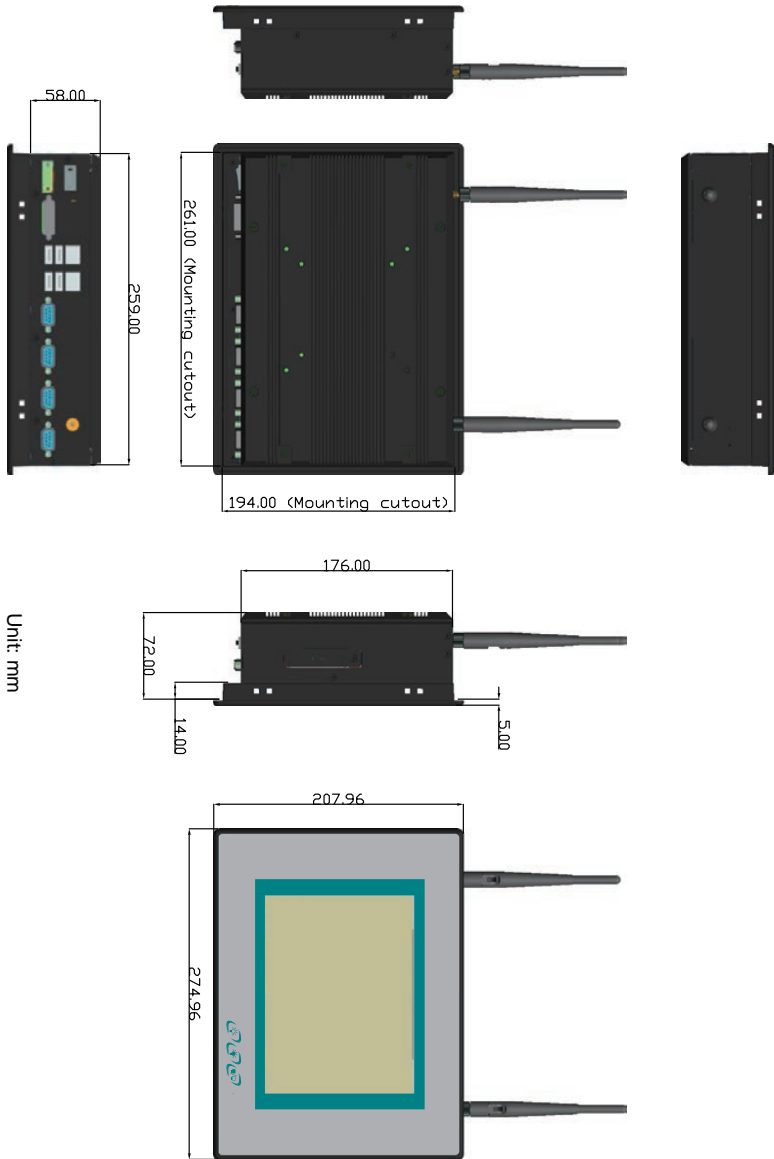



---

This page is intentionally left blank.

---

# Chapter 2

## Engine of the IPPC

## 2.1. Board Layout

The engine of TOKIN industrial panel PC is constructed with the carrier board PBC-9005P and SCDB-1443 (the CFAST board).

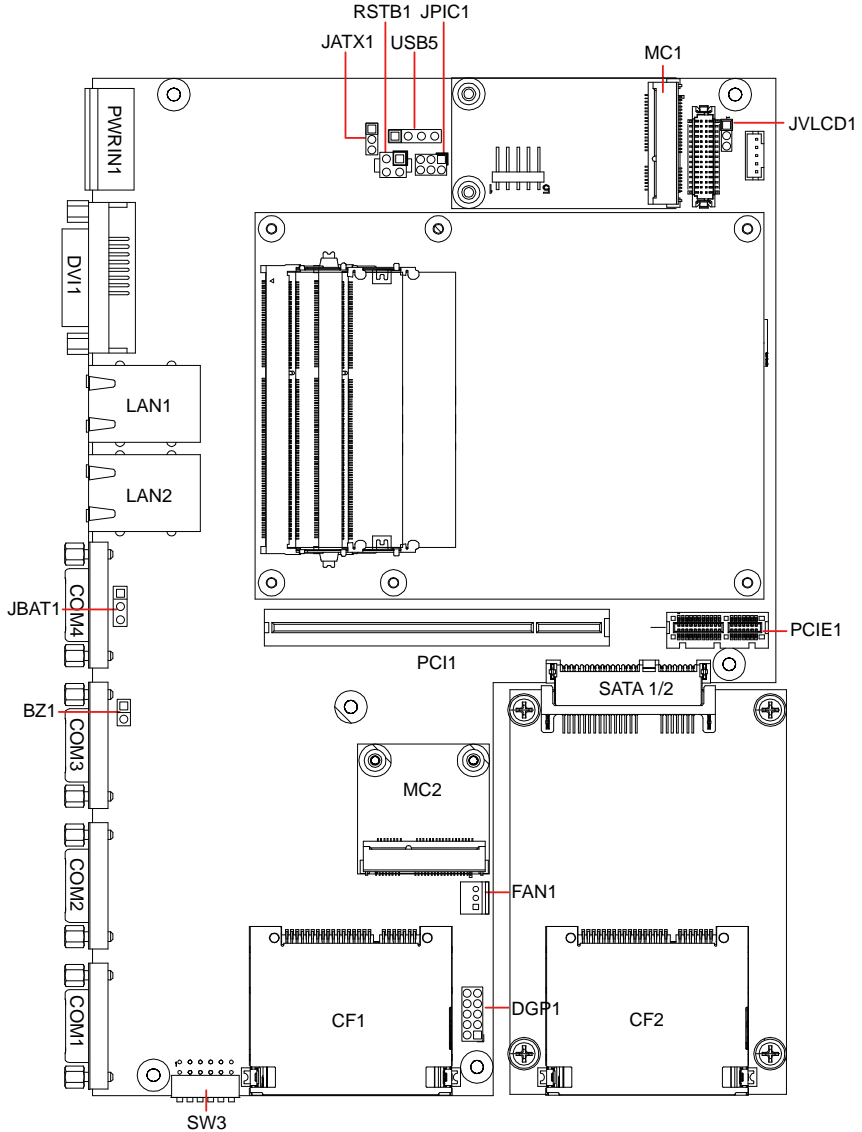

## 2.2. Jumpers and Connectors

### 2.2.1. Jumpers & Connectors List

#### Jumpers

Label	Function
JBAT1	CMOS Jumper Setting
JATX1	AT/ATX Mode Selector
JVLCD1	LVDS VCC Selector
SW3	RS232/485 Mode Switch



#### Connectors

Label	Function
JPIC1	PIC Programming Pin Header
USB5	USB KEY PRO Pin Header
BZ1	Buzzer Pin Header
DGP1	External 80 Port Pin Header
RSTB1	Reset Button Pin Header
FAN1	Fan Connector
MC1/2	Mini Card Slots (MC1 is full-size; MC2 is half-size)
CF1/2	CFast Sockets
PWRIN1	DC Adapter Power Input
DVI1	1 x DVI-I port for TOKIN-6083/6123/6153
LAN1/2	Ethernet Connectors (includes USB Connectors)
COM1/2	RS-232/RS-485 Serial Port Connectors
COM3/4	RS-232 Serial Port Connectors
SATA1/2	Serial ATA + Power Connectors
PCI1	PCI Interface Slot
PCIE1	PCIex1 Interface Slot

## 2.2.2. Jumper Settings



- **JBAT1: Clears CMOS Setting**

Connector Type: onboard 1 x 3-pin 2.54mm pin-header

Pin	Description	
1-2	Keeps CMOS (default)	
2-3	Clears CMOS	



- **JATX1: AT/ATX Mode Selector**

Connector Type: onboard 1 x 3-pin 2.00mm pin-header

Pin	Description	
1-2	AT Mode	
2-3	ATX Mode (default)	

- **JVLCD1: LVDS VCC Selector**

Connector Type: onboard 1 x 3-pin 2.00mm pin-header

Pin	Description	
1-2	VCC3 (default)	
2-3	VCC5	

### 2.2.3. DIP Switch Settings

The computer's carrier board comes with a 6-toggle DIP switch **SW3** to configure the data transmitting interfaces for serial ports COM1 and COM2. Follow the guide below to configure COM1 and COM2 between RS-232 and RS-485 (with or without terminator):



#### 1. COM1 Setting

It relies on toggles 1, 2 and 5 to set COM1 data transmission interface. Take the following settings to set COM1 to desired interface:

COM Port	Interface	Setting				
COM1	RS-232	Toggle	1	2	5	
		Position	off	off	off	
	RS-485 w/o terminator	Toggle	1	--	5	
		Position	on	--	on	
	RS-485 with terminator	Toggle	1	2	5	
		Position	on	on	on	

#### 2. COM2 Setting

It relies on toggles 3, 4 and 6 to set COM2 data transmission interface. Take the following settings to set COM2 to desired interface:

COM Port	Interface	Setting				
COM2	RS-232	Toggle	3	4	6	
		Position	off	off	off	
	RS-485 w/o terminator	Toggle	3	--	6	
		Position	on	--	on	
	RS-485 with terminator	Toggle	3	4	6	
		Position	on	on	on	

### 2.2.4. Connector Pin Assignments

- JPIC1: External PIC Programming Pin Header**

Connector Type: onboard 2.0mm pitch 2 x 3-pin headers

Pin	Description	Pin	Description
1	PIC_TX	2	ICSP-CLK
3	ICSP-DAT	4	GND
5	VCC5	6	MCU_RST



- USB5: USB KEY PRO Pin Header**

Connector Type: onboard 2.54mmmm pitch 4-pin header

Pin	Description	Pin	Description
1	VCC5	2	D-
3	D+	4	GND



- BZ1: Buzzer Pin Header**

Connector Type: onboard 2.54mmmm pitch 2-pin header

Pin	Description	Pin	Description
1	VCC5	2	GND



- DGP1: External 80 Port Pin Header**

Connector Type: onboard 2.0mm pitch 10-pin header

Pin	Description	Pin	Description
1	CLK	2	GND
3	FRAME#	4	LAD0
5	PLTRST#	6	NC
7	LAD3	8	LAD2
9	VCC3	10	LAD1



- **RSTB1: Reset Button Pin Header**

Connector Type: onboard 2.54mm pitch 4-pin headers

Pin	Description	Pin	Description
1	SYS_RESET#	2	GND
3	PWR_IN_SW#	4	GND



- **FAN1: Fan Connector**

Connector Type: onboard 3-pin wafer connector

Pin	Description
1	GND
2	+12V
3	NC



- **COM1 &COM2: Serial port DB9 connectors**

Connector Type: External 9-pin D-sub male connectors

Pin	Description	Pin	Description
1	DCD / 485-	2	RXD / 485+
3	TXD	4	DTR
5	GND	6	DSR
7	RTS	8	CTS
9	RI		

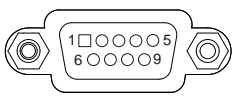

- **COM3 &COM4: Serial port DB9 connectors**

Connector Type: External 9-pin D-sub male connectors

Pin	Description	Pin	Description
1	DCD	2	RXD
3	TXD	4	DTR
5	GND	6	DSR
7	RTS	8	CTS
9	RI		

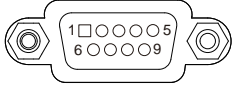



---

This page is intentionally left blank.

---

# Chapter 3

## Installation and Maintenance

### 3.1. Install SSD, PCIe, PCI and Mini-card

The TOKIN industrial panel PC is based upon modular design for easier maintenance. This section will cover the simple hardware installations for the IPPC. Make sure the IPPC is powered off before any action is taken.

#### 3.1.1. Remove the Rear Panel

1. Place the Industrial PC upside down. See the picture below and find where the screws are. Loosen and remove these screws and save them for later use.

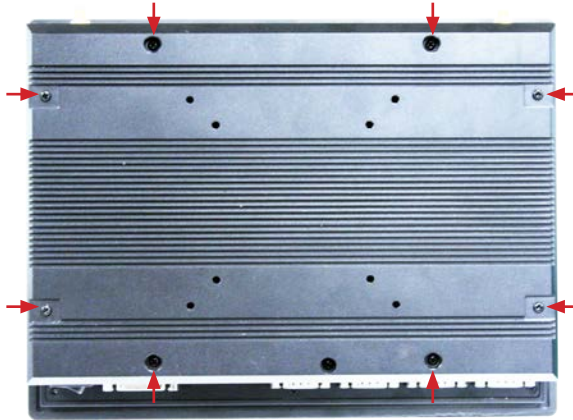

2. Gently dismount the rear panel. Take a look at its inside.

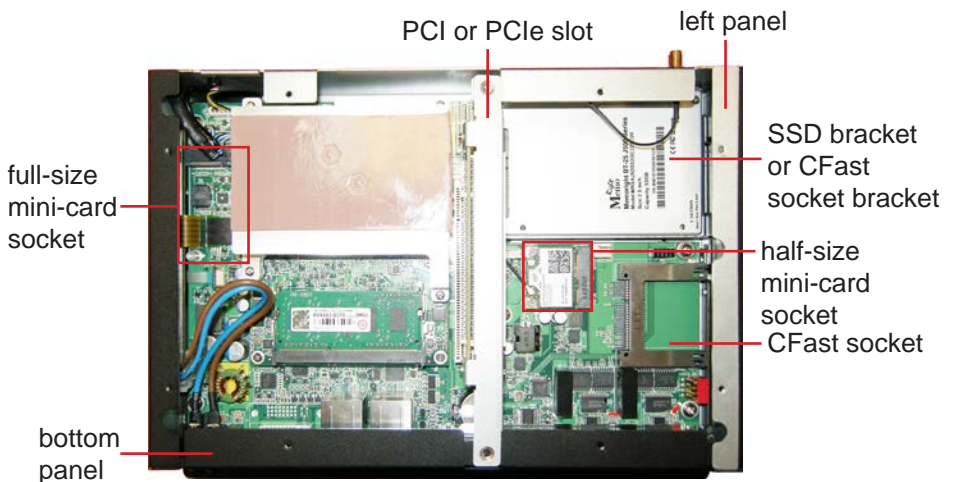



### 3.1.2. Install SSD

1. Remove the computer's rear panel as described in [3.1.1. Remove the Rear Panel](#) on page [25](#).
2. Loosen and remove the four screws at the left and bottom sides. Gently dismount the left panel.

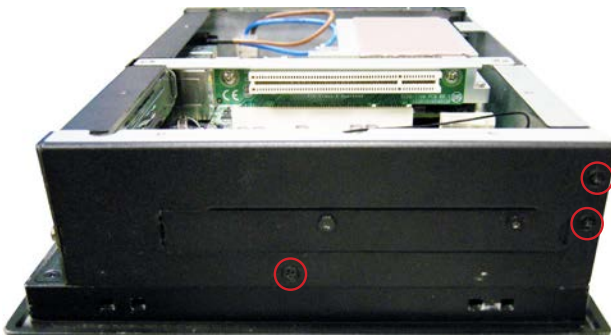

- Loosen and remove the screw that fixes the SSD bracket. Then remove the bracket.

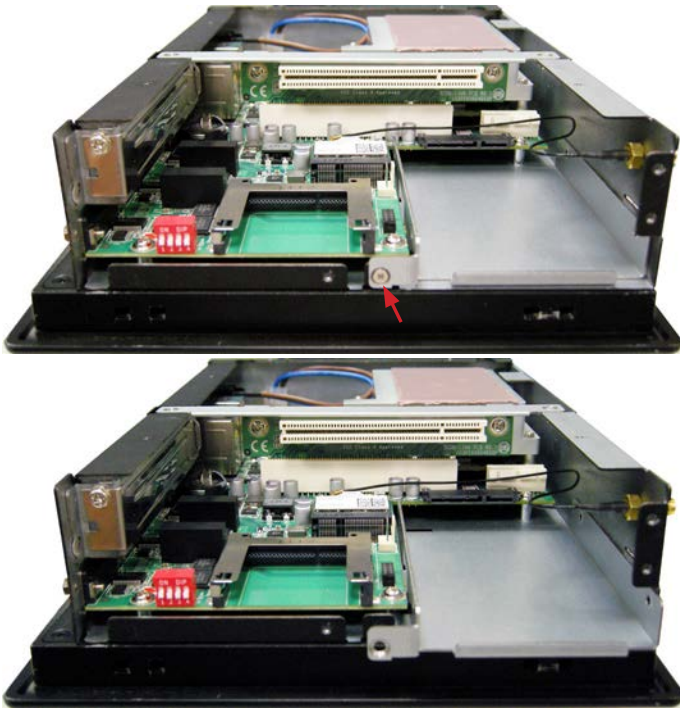

- Attach the SSD to the bracket and fix them together by using screws at the four corners.

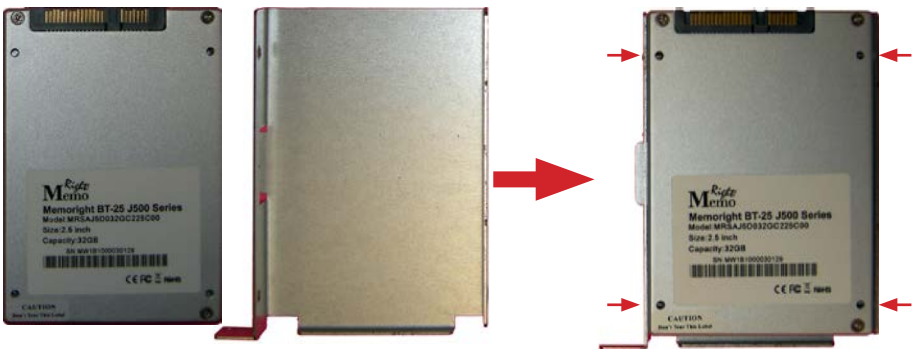

5. Restore the bracket (with the SSD) and fix them in place.

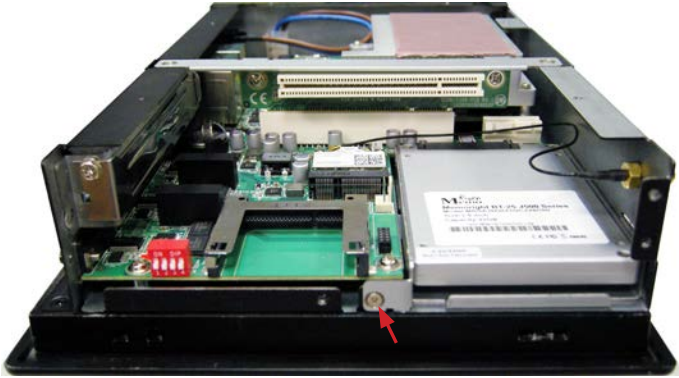

6. The SSD bracket is one of the standard accessories included in the accessory box. This SSD bracket can be replaced by an additional CFAST socket bracket.

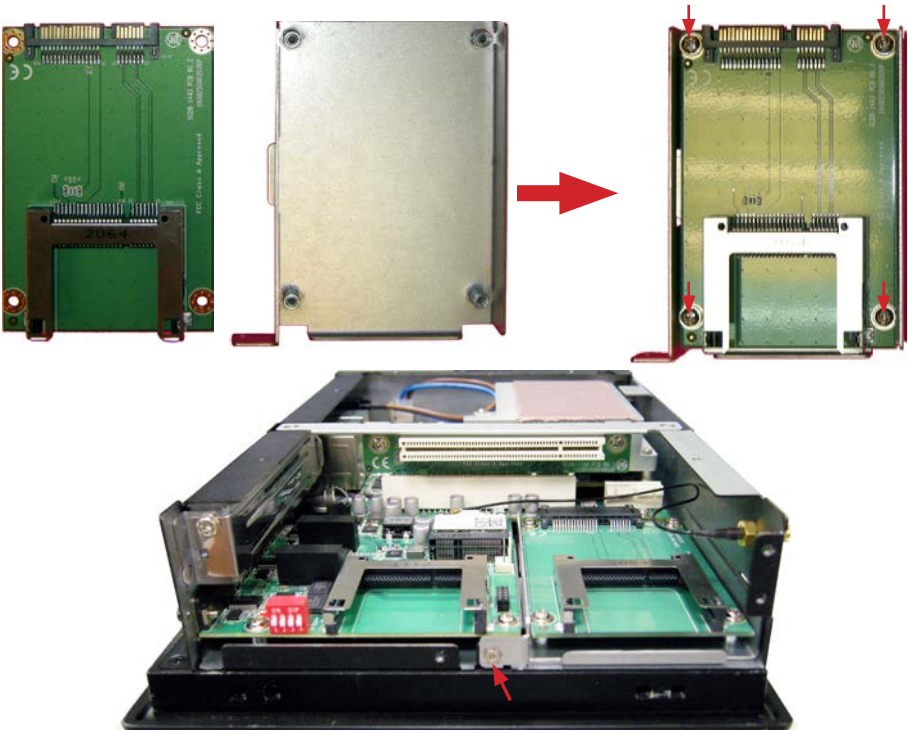

### 3.1.3. Install PCI Card

1. Loosen and remove the screw as marked in the picture below. Carefully dismount the bracket.



2. Insert your desired PCI card into the slot and fix it in place.



### 3.1.4. Install PCIe Card

1. The PCI slot can be replaced with the PCIe slot included in the accessory kit. Loosen and remove the two screws that fixes the PCI slot first of all. Carefully remove the PCI slot and insert the PCIe slot in place.

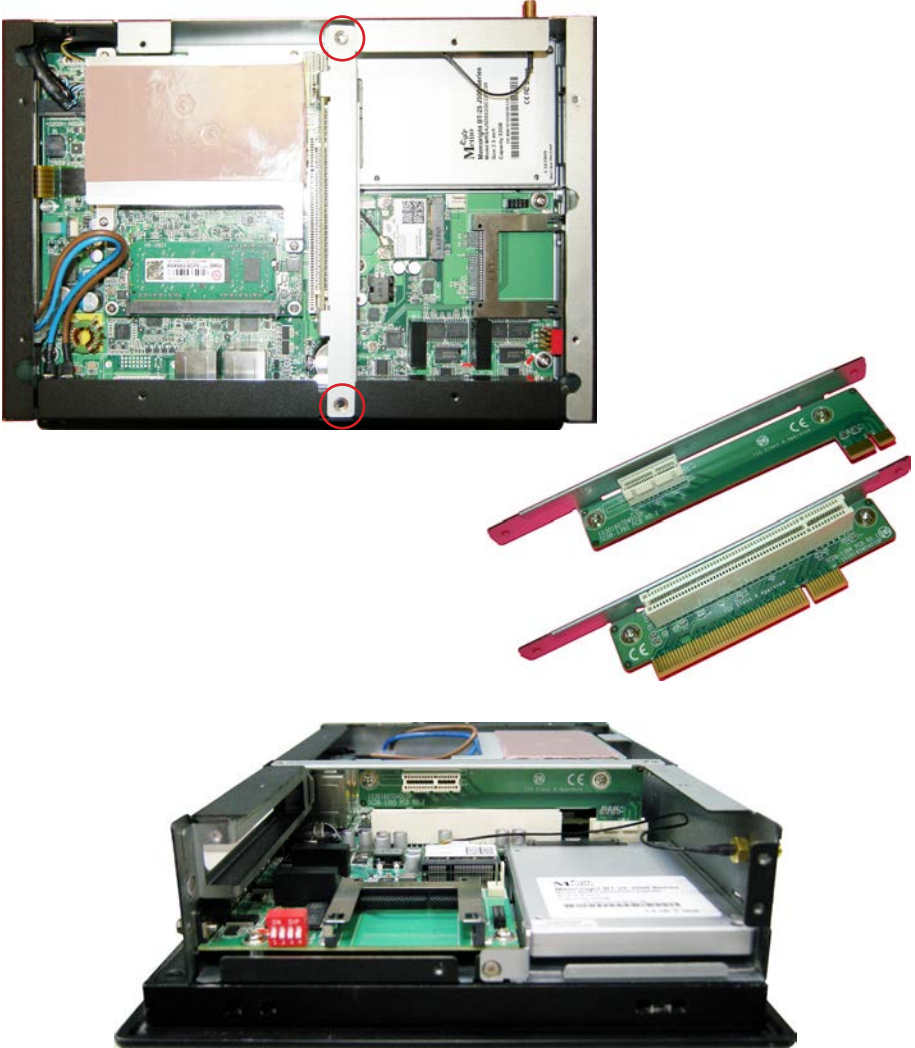



2. Insert your desired PCIe x 1 card into the slot and fasten it.



### 3.1.5. Install Mini-card

1. Locate the Mini-card socket.
2. Plug a Bluetooth or HSUPA module to the socket's connector by a slanted angle. Note the notch on the card should meet the break on the connector.
3. Press down the module and fix it in place using two screws.

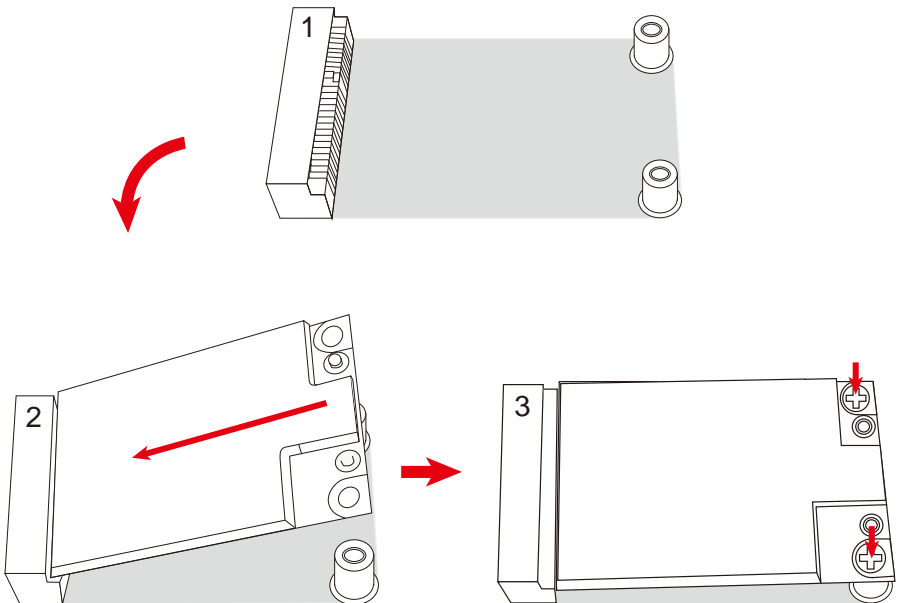

### 3.2. Install/Uninstall CFast Card

If the OS is installed on the CFast card, power off the IPPC before proceeding with the uninstallation of CFast Card.

1. See the picture below. Loosen and remove the screw. Dismount the CFast card door. Keep the card door for later use.



2. Insert your CFast card into either of the slots as the pictures below show.

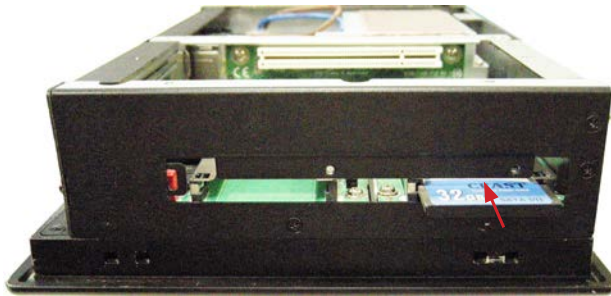

3. If later it is needed to remove the CFast card, simply remove the card door and push-eject the CFast card.

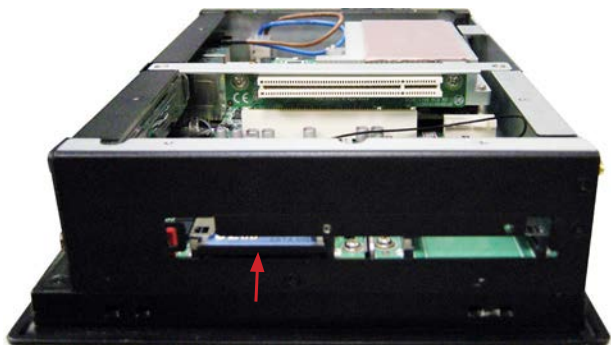

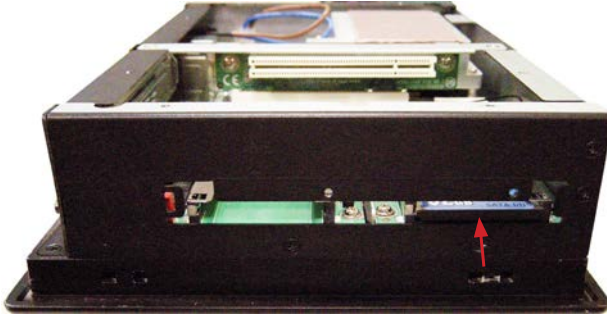

### 3.3. Install Internal USB Drive

As some critical application programs rely on USB keys to run, an USB drive is therefore necessary to store the related encrypted keys and digital certificates. The TOKIN-Series IPPC supports an USB drive to work inside the chassis to deliver extraordinary protection against any unauthorized tamper to the USB drive from the outside.

To install an Internal USB drive:

1. Remove the rear panel from the IPPC as described in [3.1.1. Remove the Rear Panel](#) on page [25](#).
2. See the picture below. From the right side of the chassis, loosen and remove the two screws that fix the internal USB bracket. Keep the screws for later reinstallation.

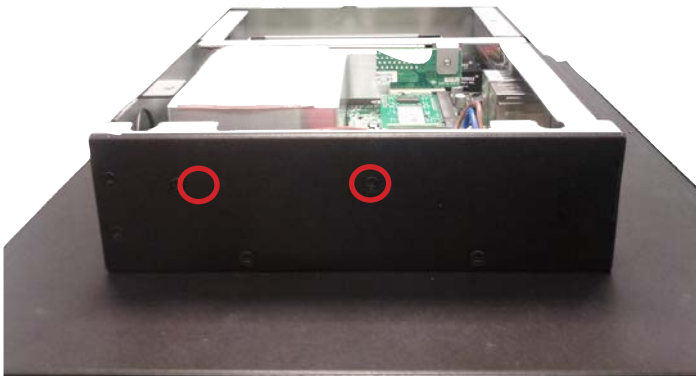

3. Detach the internal USB bracket from the carrier board.

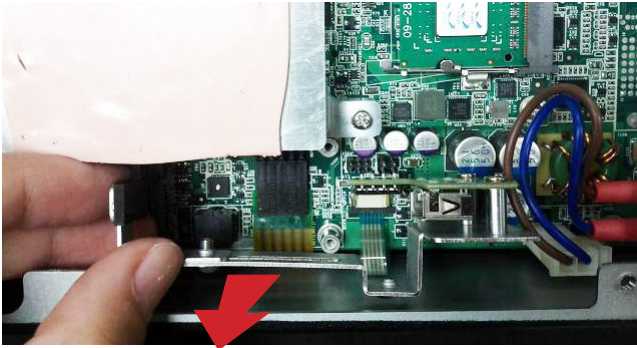

Detach the internal USB bracket.

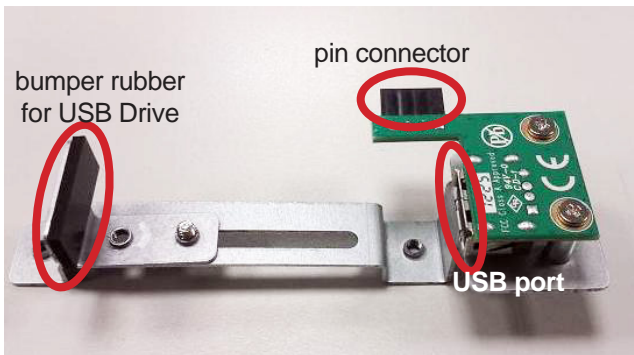

Take a look at the detached USB bracket.

4. Install an USB drive to the USB bracket.



## Installation and Maintenance

---

- To reinforce the installation of the USB drive, slide the bumper rubber to the installed USB drive by loosening and relocating the bolt as displayed in the picture below.

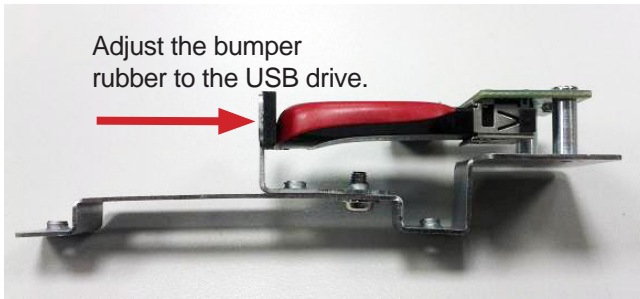
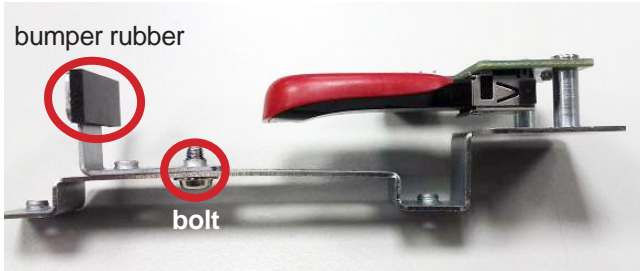

- Find the internal USB connector on the carrier board. Reinstall the internal USB bracket (bearing the USB drive) by the two screws you saved in step 2.

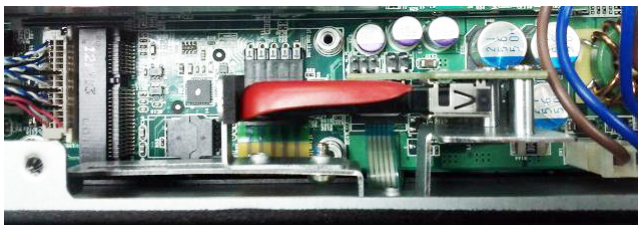
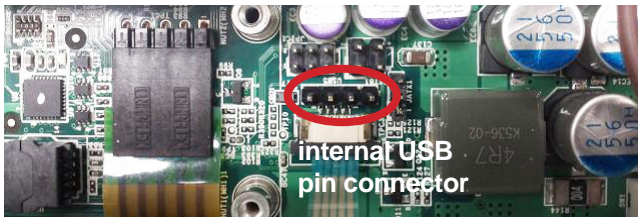

7. Restore the rear panel to the IPPC.

### 3.4. Panel Mounting

There are two approaches to mount the IPPC to a panel - by either clamps or brackets. The following sections will walk your through these two approaches.

#### 3.4.1. Panel Mounting with Clamps

1. Have the panel-mounting clamps included in the accessory pack.
2. Attach the clamps to the slots around the edges of the panel to mount.
3. Fix the IPPC to panel by using screws on the said clamps.

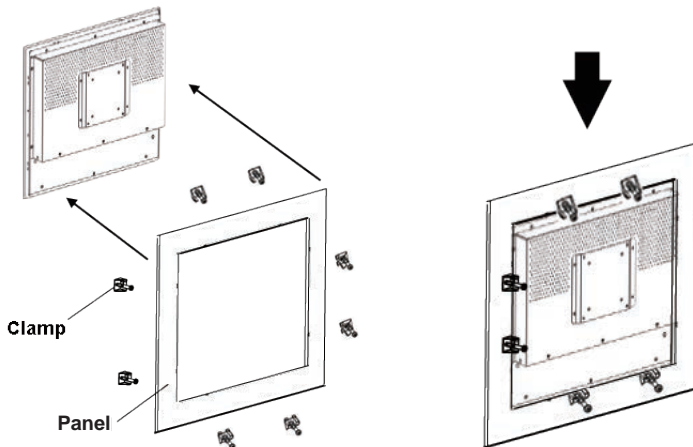

### 3.4.2. Panel Mounting with Brackets

Before you proceed, make sure the panel to mount is no thicker than 4mm.

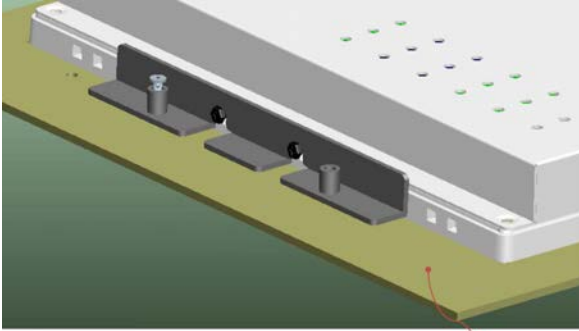

The panel to mount must be no thicker than 4mm.

Then follow the steps below to mount the IPPC to a panel using brackets:

1. Attach two screws to each left and right sides of the IPPC.

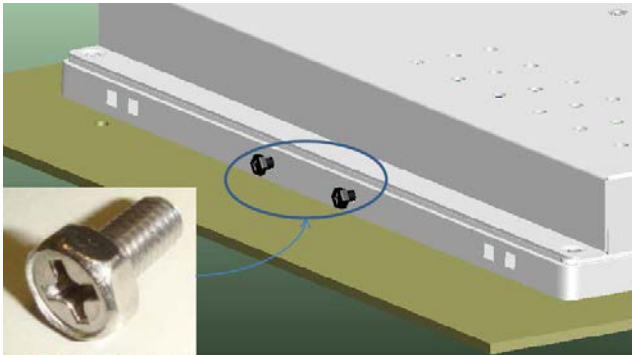

3511040805110P



2. Assemble the brackets to each side. Fasten the screws.

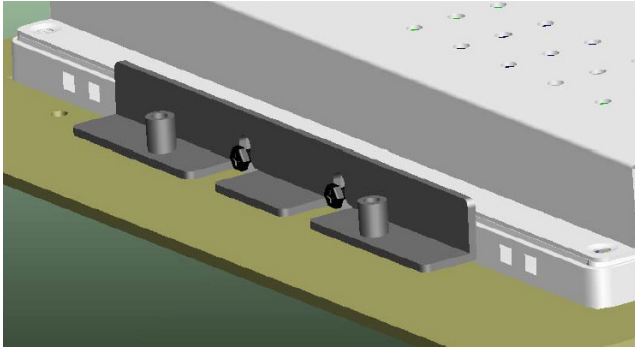

3. Fine-tune the mounting firmness by adjusting bolts tightness.

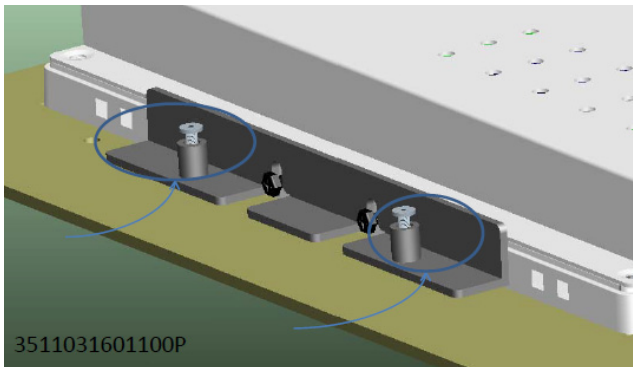

### 3.5. VESA Arm Mounting

The TOKIN-Series supports VESA arm mounting of 75 x 75mm or 100 x 100mm mounting hole pattern. See the illustration below for the example.

1. Have the VESA arm and the four mounting screws that come with it.
2. Locate the VESA compliant holes at the rear of the IPPC.
3. Attach the VESA arm to the rear of the IPPC by meeting the screws holes on the VESA arm and the IPPC's rear.
4. Fix them together with four screws.

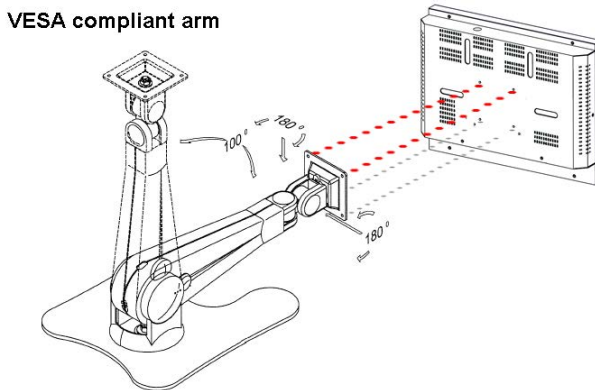

### 3.6. Wire DC-Input Power Source



**Warning** Only trained and qualified personnel are allowed to install or replace this equipment.

Follow the instructions below for connecting the computer to a DC-input power source.

1. Before wiring, make sure the power source is disconnected.
2. Find the terminal block in the accessory box.
3. Use the wire-stripping tool to strip a short insulation segment from the output wires of the DC power source.
4. Identify the positive and negative feed positions for the terminal block connection. See the symbols printed on the rear panel indicating the polarities and DC-input power range in voltages.
5. Insert the exposed wires into the terminal block plugs. Only wires with insulation should extend from the terminal block plugs. Note that the polarities between the wires and the terminal block plugs must be positive to positive and negative to negative.

**Terminal Block**

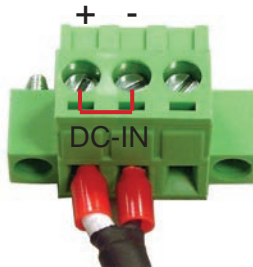

6. Either earth-ground the pin 3 on the terminal block or short the pin 2 and pin 3 on the terminal block.

Earth-ground the pin 3.

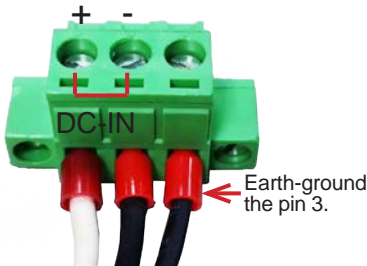

or

Short the pin 2 and pin 3.

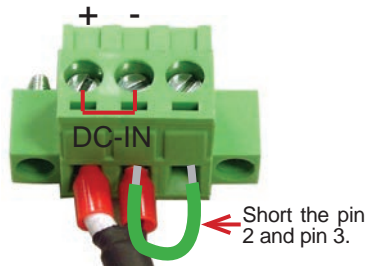

7. Use a slotted screwdriver to tighten the captive screws. Plug the terminal block firmly, which wired, into the power receptacle at the bottom of the computer.

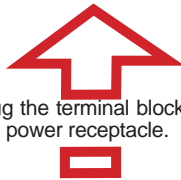
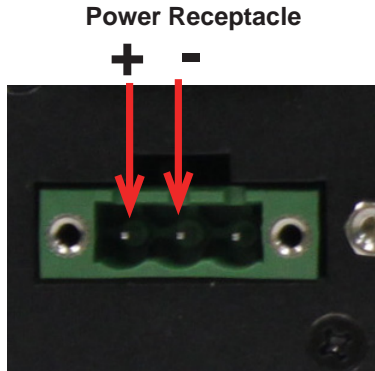

Plug the terminal block to the power receptacle.

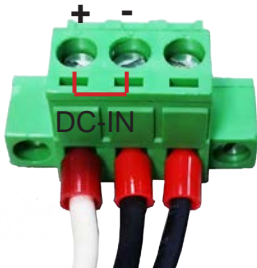

Terminal block with pin 3 earth-grounded.

or

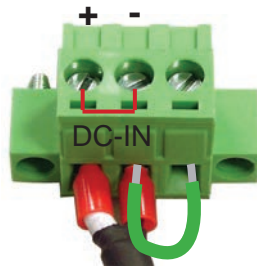

Terminal block with pin 2 and pin 3 shorted.

---

This page is intentionally left blank.

---

# Chapter 4

## Driver & AP

## 4.1. Before Installation

After everything aforementioned is done, proceed to install the necessary drivers and the application so the IPPC can function for you. The following instructions take Windows XP (x86) as the exemplary OS. Different OS may vary slightly regarding driver/AP installation, but generally they are similar. Note to install the drivers as the sequece below:

**CHIPSET→Framework 3.5→VGA→LAN→TOUCH**

**Follow This Procedure** to install all necessary pieces of software in most cases to prevent errors.

Find the drivers & AP for Windows 7 & Windows XP on the CD that goes with your purchase. The paths to find them on CD are tabulated as below.

For Models with Intel® Celeron® 827E processor :

### Windows XP

Driver & AP	Path
CHIPSET	\Chipset
Framework 3.5	\NET Framework 3.5
VGA	\Graphic\WinXP\x64
	\Graphic\WinXP\x86
LAN	\LAN\17.1\WinXP
TOUCH	\Touch\PenMount Windows Universal Driver V2.2.0.283. (Win7_32_64bit_WHQL)

### Windows 7

Driver & AP	Path
CHIPSET	\Chipset
Framework 3.5	\NET Framework 3.5
VGA	\Graphic\Win7\x64
	\Graphic\Win7\x86
LAN	\LAN\17.1\Win7
TOUCH	\Touch\PenMount Windows Universal Driver V2.2.0.283. (Win7_32_64bit_WHQL)

For Models with Intel® Atom™ D2550 processor :

### Windows XP

Driver & AP	Path
Chipset	\CHIPSET\Win_x86 \CHIPSET\Win_x64
.NET Framework 3.5	\NET Framework 3.5
VGA	\GRAPHIC\WIN XP\Utilities
LAN	\LAN\WinXP
Touch	\TOUCH\PenMount Windows Universal Driver V2.2.0.283.( for XP Embedded)\repository
AHCI	\AHCI

### Windows 7

Driver & AP	Path
Chipset	\CHIPSET\Win_x86 \CHIPSET\Win_x64
.NET Framework 3.5	\NET Framework 3.5
VGA	\GRAPHIC\WIN 7
LAN	\LAN\Win7
Touch	\TOUCH\PenMount Windows Universal Driver V2.2.0.283. (Win7_32_64bit_WHQL)
AHCI	\AHCI



## 4.2. Drivers

### 4.2.1. CHIPSET

1. Run the executable file “infnst\_autol.exe” as described in [4.1. Before Installation](#) on page 45.

The installation wizard then opens and starts to extract the files required for driver installation.

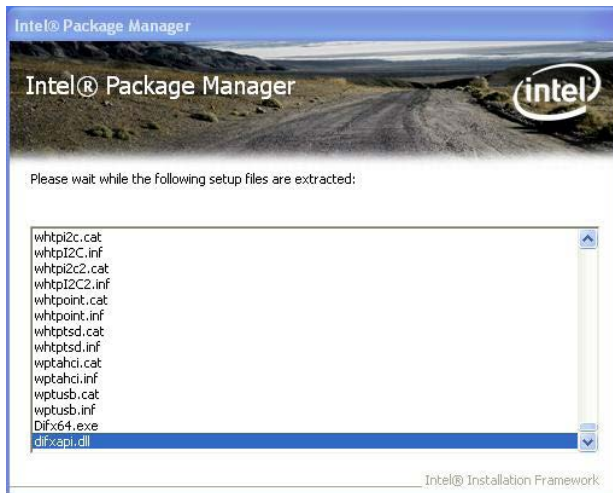

2. Click **Next** to proceed.



3. Read the license agreement and click **Yes** to proceed.



4. Read the readme file and click **Next** to proceed.

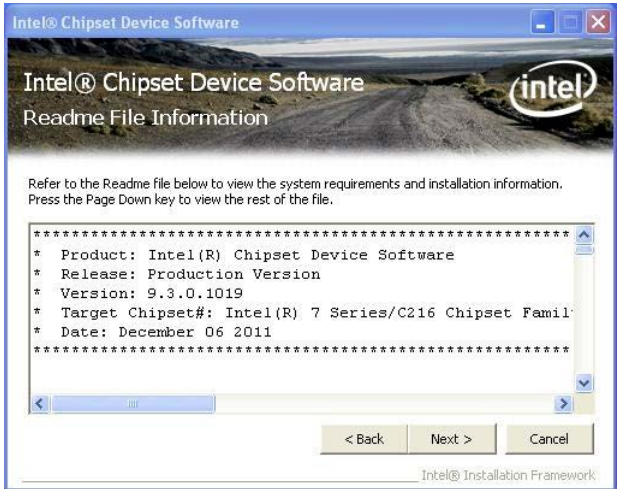

5. The installation wizard then starts to proceed with some setup operations.



6. Once the setup operations are through, click **Next** to proceed.

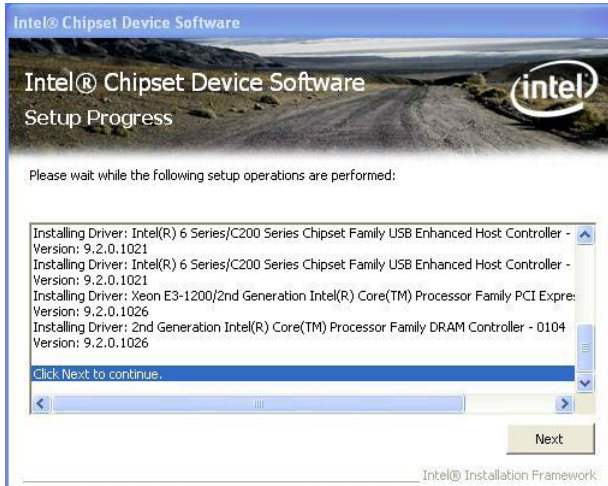

7. Click **Finish** to finish and quit the driver installation.



## 4.2.2. Framework 3.5

1. Run the executable file “NET Framework 3.5.exe” at the suggested path (\ NET Framework 3.5) as described in [4.1. Before Installation](#) on page [45](#).

Files extraction is then triggered for the driver installation.

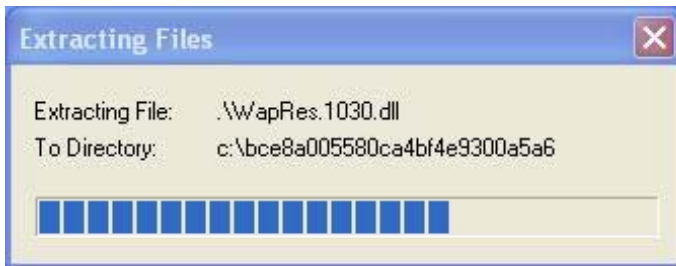

Once the files extraction is through, the installation wizard opens.

2. Select **I have read and ACCEPT the terms of the License Agreement** and click **Install** to proceed.



3. The driver installation then starts and progresses.

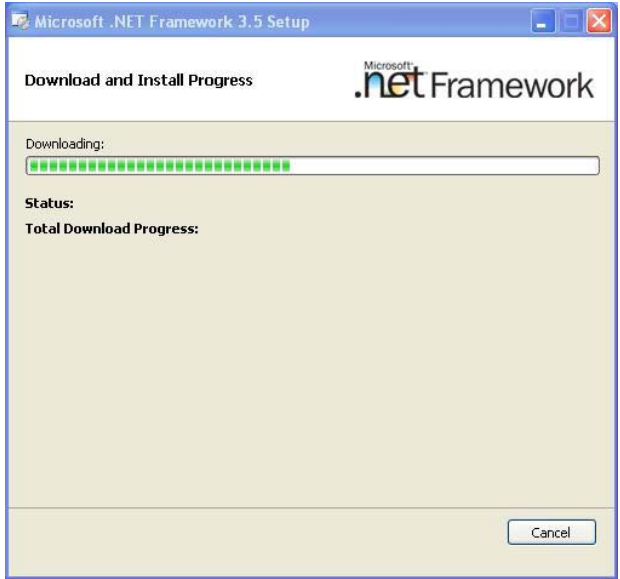

4. Once the installation is through, click **Exit** to finish and quit the installation.

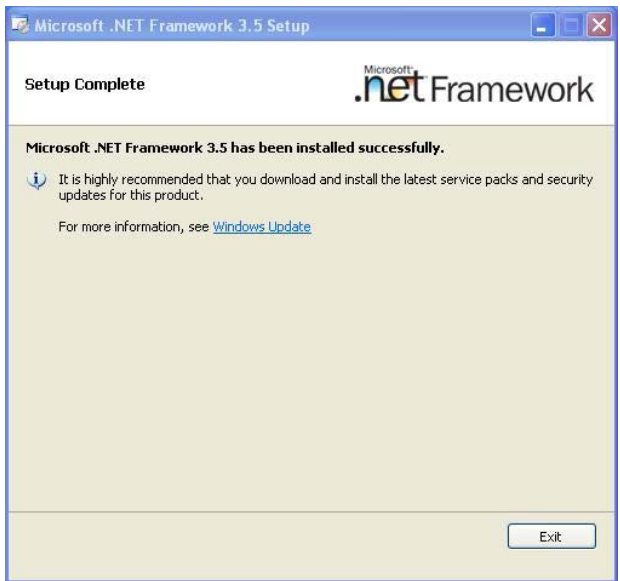

### 4.2.3. VGA

For Models with Intel® Celeron® 827E, please refer to the following steps.

1. Run the executable file “winxp\_14469.exe” at the suggested path (\Graphic WinXP\x86) as described in [4.1. Before Installation](#) on page [45](#). The installation wizard then opens.

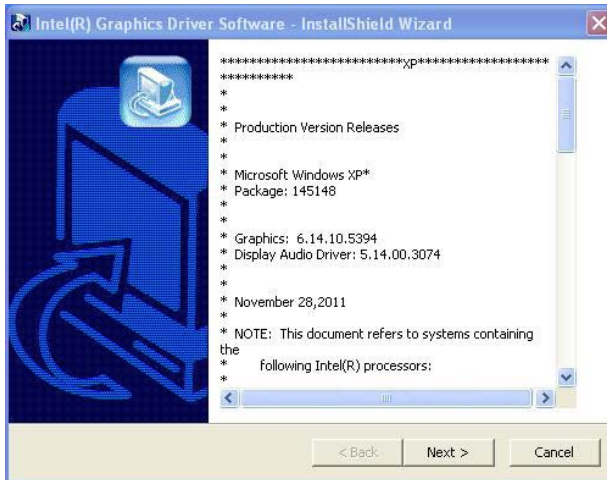

2. Click **Next** to proceed. The installation wizard then starts to extract the files required for the installation.

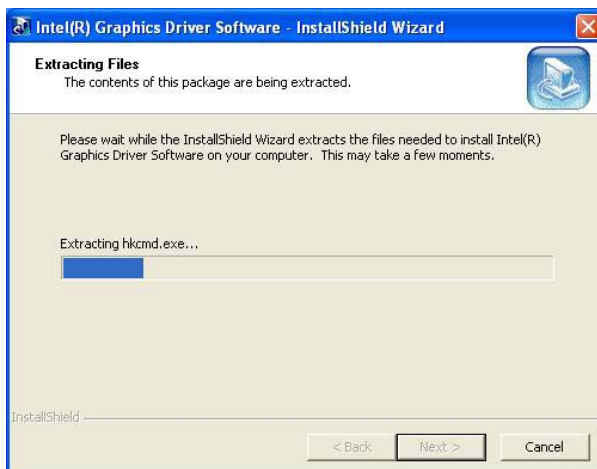

- Once the files extraction is through, click **Next** to proceed.



- Read the license agreement and click **Yes** to proceed.





5. Read the readme file and click **Next** to proceed.

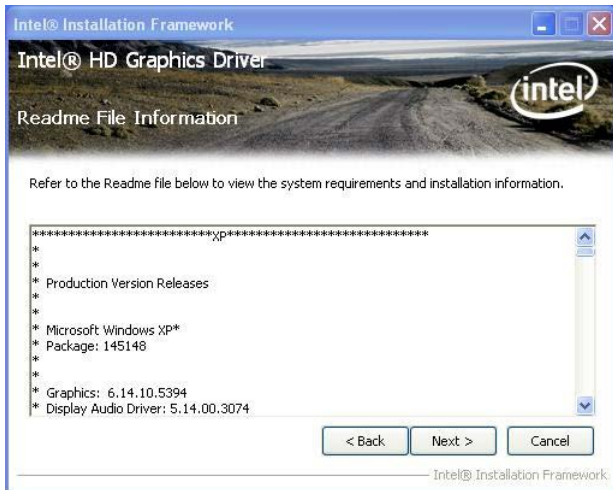

Setup then starts and progresses.

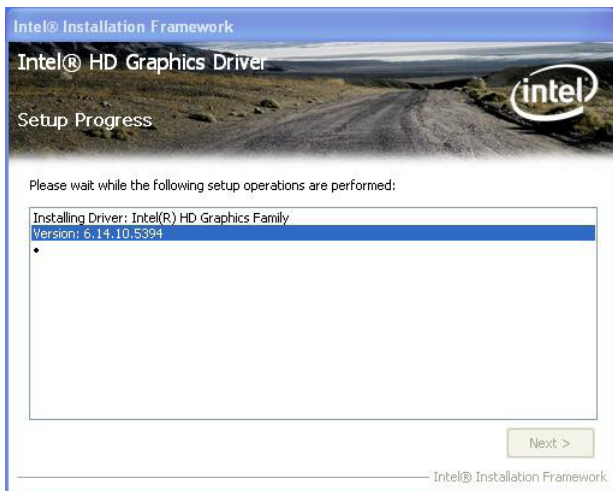

6. Once the setup is through, click **Next** to proceed.

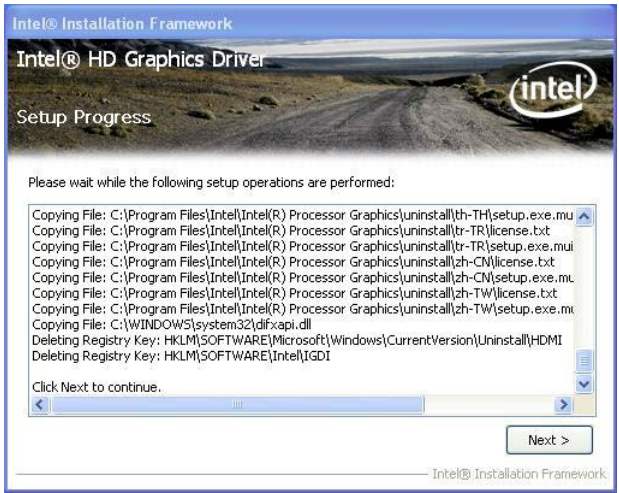

7. Select **Yes, I want to restart this computer now** and click **Finish**.



For Models with Intel® Atom™ D2550 processor, please refer to the following steps.

1. Run the executable file “Setup.exe” at the folder **\\GRAPHIC\WIN XP\ Utilities** as described in [4.1. Before Installation](#) on page 45.

A dialog opens onscreen.

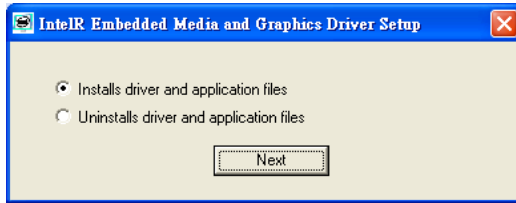

2. Select **Installs driver and application files**, and click **Next** to proceed.

A dialog then opens showing the software license agreement.

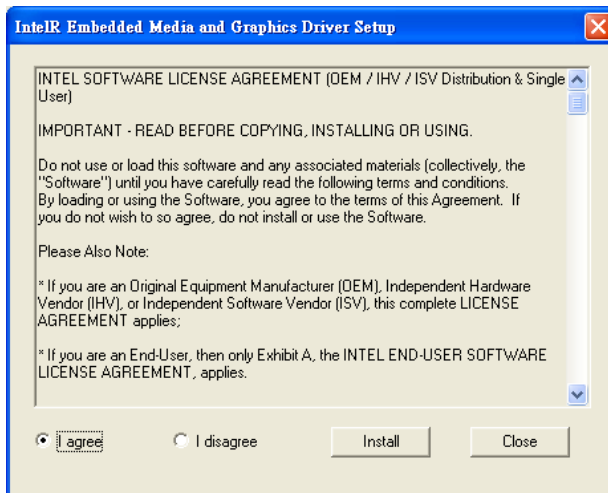

3. Select **I agree** and click **Install** to proceed.

The driver files then start to install on the computer.

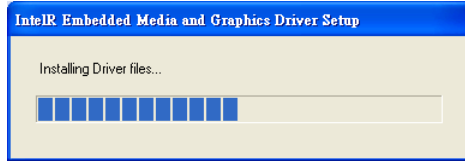

Once the installation is through, you are prompted to restart the computer to apply the change.

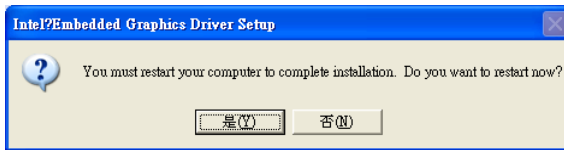

4. Click **Yes** to restart the system by the support of the newly installed graphics driver.

#### 4.2.4. LAN

1. Run the executable file “PROWin32.exe” at the suggested path as described in [4.1. Before Installation](#) on page [45](#).

Files extraction then starts and progresses.

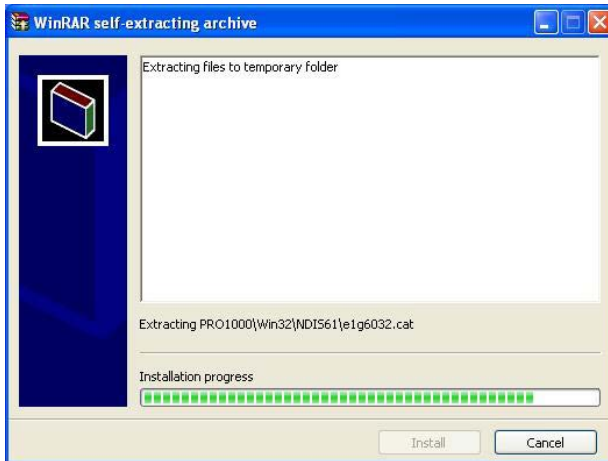

2. Once the files extraction is through, click **Next** to proceed.



3. Read the agreement. Select **I accept the terms in the License agreement** and click **Next** to proceed.



4. Select the program features to install and click **Next** to proceed.

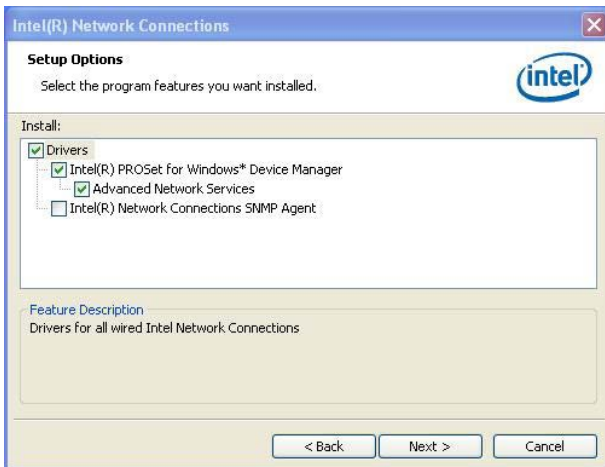

5. Click **Install** to proceed.

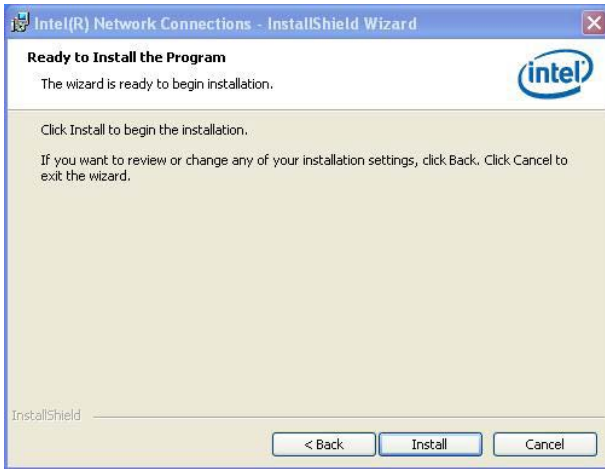

The driver installation then starts and progresses.

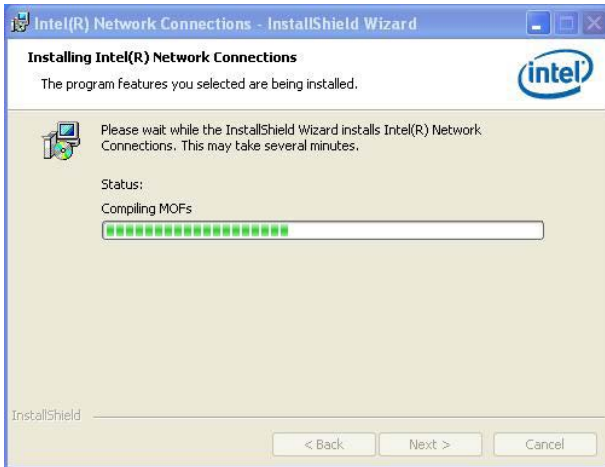

6. Once the driver installation is through, click **Finish** to finish and quit the installation.

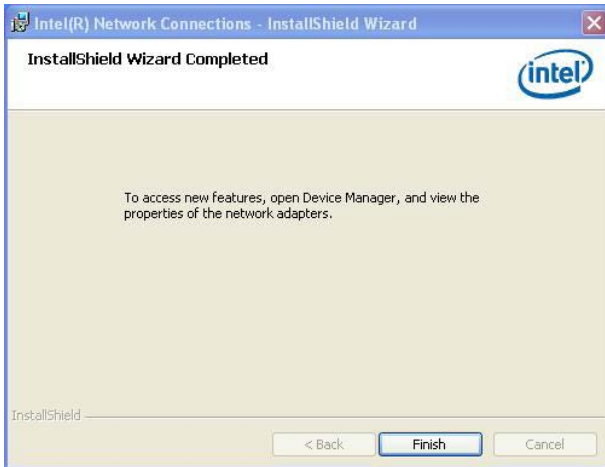



## 4.2.5. TOUCH

1. Run the executable file “Setup.exe” at the suggested path (TOUCH\PenMount Windows Universal Driver V2.2.0.283.(Win7\_32\_64bit\_WHQL)) as described in [4.1. Before Installation](#) on page [45](#).

The installation wizard then opens. Click **Next** to proceed.



2. Read the license agreement and click **I Agree** to proceed.



3. Select where to install the driver. Then click **Install** to proceed.

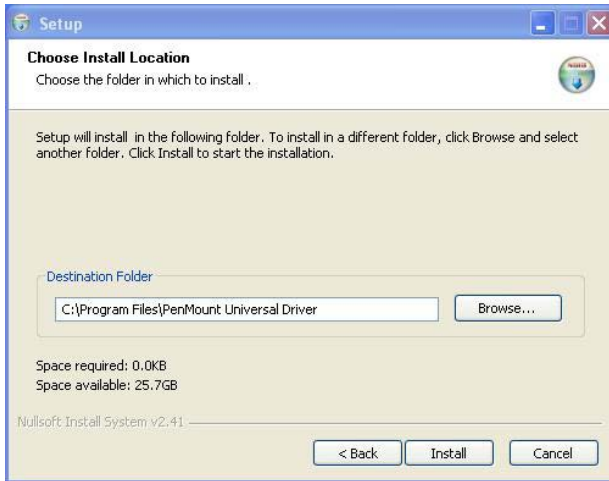

4. Once the installation is through, click **Finish** to finish and quit the installation.

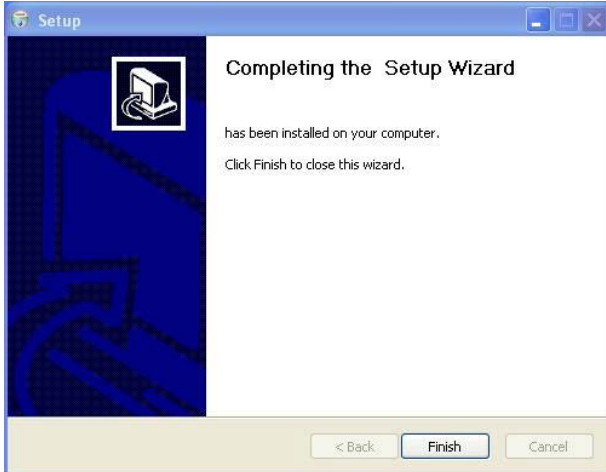

## 4.2.6. AHCI (Advanced Host Controller Interface)

For Models with Intel® Atom™ D2550 processor only:

1. Run the executable file “STOR\_allIOS\_10.6.0.1022.exe” at the folder **VAHCI** as described in [4.1. Before Installation](#) on page [45](#).

The installation wizard then opens and prepares to install the driver.

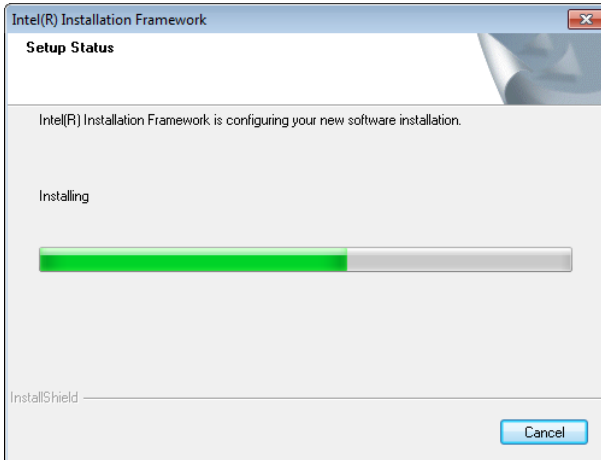

2. Once the preparation is through, a window opens prompting to install Intel® Rapid Storage Technology, which enables AHCI for SATA. Click **Next** to proceed.



3. Read the license agreement and click **Yes** to proceed.



4. Read the readme file and click **Next** to proceed.

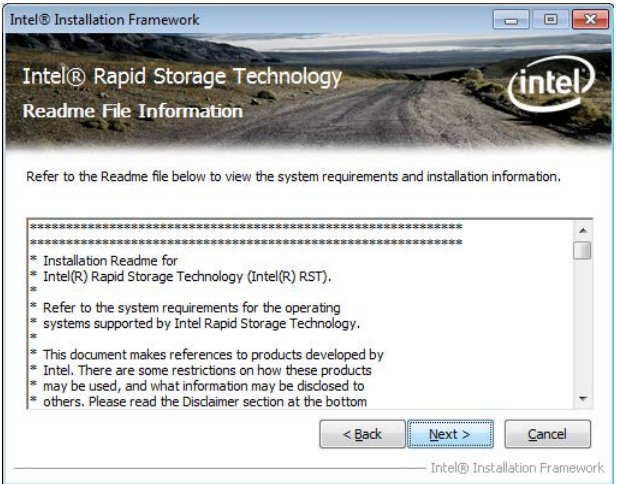

5. A **Setup Progress** window opens. Driver installation then starts and progresses.

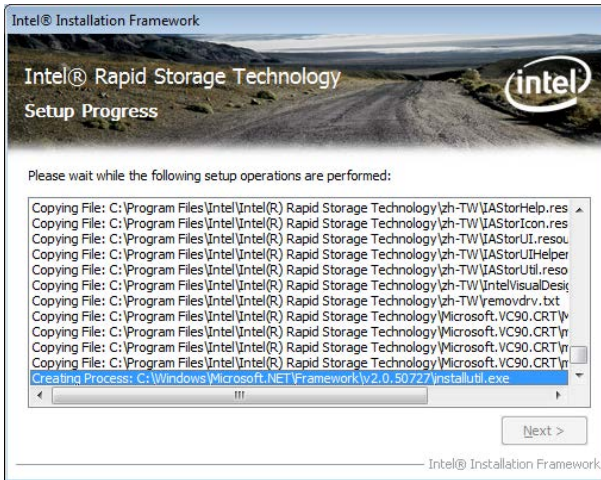

6. Once the installation is through, the **Next** button on **Setup Progress** window becomes available. Click **Next** to proceed.

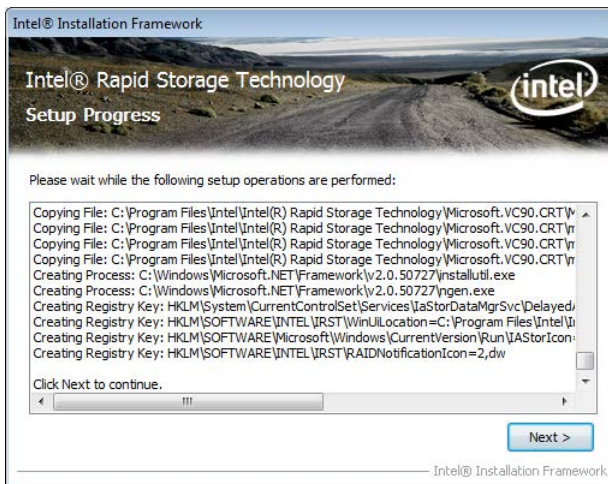

7. Select **Yes, I want to restart this computer now.** and click **Finish** button to restart the system to immediately apply the change, or select **No, I will restart this computer later.**



---

# Chapter 5

## BIOS

## BIOS

The BIOS SETUP utility for TOKIN-Series is featured by American Megatrends Inc to configure the system settings stored in the system's BIOS ROM. The BIOS is activated once the IPPC powers on. When the IPPC is off, the battery on the main board supplies power to BIOS RAM.

To enter the BIOS SETUP utility, press-and-hold the "Delete" key upon powering on the IPPC.

Aptio Setup Utility - Copyright (C) 2010 American Megatrends, Inc.

Main Advanced Chipset Boot Security Save & Exit

BIOS Information		Set the Date. Use Tab to switch between Data elements.
BIOS Vendor	American Megatrends	
Core Version	4.6.4.0	
Compliancy	UEFI 2.1	
BIOS Version	T6153/827E 1.00	
Build Date and Time	09/11/2011 15:07:58	
System Date	[Wed 09/12/2012]	
System Time	[13:29:21]	
Access Level	Administrator	→: Select Screen ↑↓: Select Item Enter: Select +/-: Change Opt. F1: General Help F2: Previous Values F9: Optimized Defaults F10: Save & Exit ESC: Exit

Version 2.10.1208. Copyright (C) 2010 American Megatrends, Inc.

The featured settings are:

Menu	Description
<b>Main</b>	See <a href="#">5.1. Main</a> on page <a href="#">72</a> .
<b>Advanced</b>	See <a href="#">5.2. Advanced</a> on page <a href="#">74</a> .
<b>Chipset</b>	See <a href="#">5.3. Chipset</a> on page <a href="#">79</a> .
<b>Boot</b>	See <a href="#">5.3.3. Host Bridge</a> on page <a href="#">86</a> .
<b>Security</b>	See <a href="#">5.5. Security</a> on page <a href="#">92</a> .
<b>Save &amp; Exit</b>	See <a href="#">5.6. Save &amp; Exit</a> on page <a href="#">94</a> .



## Key Commands

The BIOS SETUP utility relies on a keyboard to receive user's instructions. Hit the following keys to navigate within the utility and use it.

Keystroke	Function
← →	Moves left/right between the top menus.
↓ ↑	Moves up/down between highlight items.
Enter	Selects an highlighted item/field.
Esc	<ul style="list-style-type: none"><li>▶ On the top menu Use <b>Esc</b> to quit the utility without saving changes to CMOS. (The screen will prompt a message asking you to select <b>OK</b> or <b>Cancel</b> for exiting discarding changes.</li><li>▶ On the submenus Use <b>Esc</b> to quit current screen and return to the top menu.</li></ul>
Page Up / +	Increases current value to the next higher value or switches between available options.
Page Down / -	Decreases current value to the next lower value or switches between available options.
F1	Opens the <b>Help</b> of the BIOS SETUP utility.
F10	Exits the utility saving the changes that have been made. (The screen then prompts a message asking you to select <b>OK</b> or <b>Cancel</b> to exit saving changes.)

**Note:** Pay attention to the "WARNING" that shows at the left frame when making any change to the BIOS settings.

## 5.1. Main

The **Main** menu features **System Date** and **System Time** settings while displaying some BIOS info.

The BIOS info displayed are:

Item	Description
<b>BIOS Vendor</b>	Delivers the provider of the BIOS Setup utility.
<b>Core Version</b>	Delivers the version info of the core.
<b>Complieny</b>	Delivers UEFI support.
<b>BIOS Version</b>	Delivers BIOS version info.
<b>Build Date and Time</b>	Delivers the date and time the BIOS Setup utility was made/updated.

For Models with Intel® Celeron® 827E, please refer to the following picture.

The screenshot shows the Aptio Setup Utility interface. At the top, it says "Aptio Setup Utility - Copyright (C) 2010 American Megatrends, Inc." Below this is a navigation bar with "Main" selected, followed by "Advanced", "Chipset", "Boot", "Security", and "Save & Exit". The main area is divided into two columns. The left column lists BIOS information: BIOS Vendor (American Megatrends), Core Version (4.6.4.0), Complieny (UEFI 2.1), BIOS Version (T6153/827E 1.00), Build Date and Time (09/11/2011 15:07:58), System Date ([Wed 09/12/2012]), System Time ([13:29:21]), and Access Level (Administrator). The right column contains instructions: "Set the Date. Use Tab to switch between Data elements." and a list of keyboard shortcuts: →+: Select Screen, ↑↓: Select Item, Enter: Select, +/-: Change Opt., F1: General Help, F2: Previous Values, F9: Optimized Defaults, F10: Save & Exit, ESC: Exit. At the bottom, it says "Version 2.10.1208. Copyright (C) 2010 American Megatrends, Inc."

For Models with Intel® Atom™ D2550, please refer to the following picture.

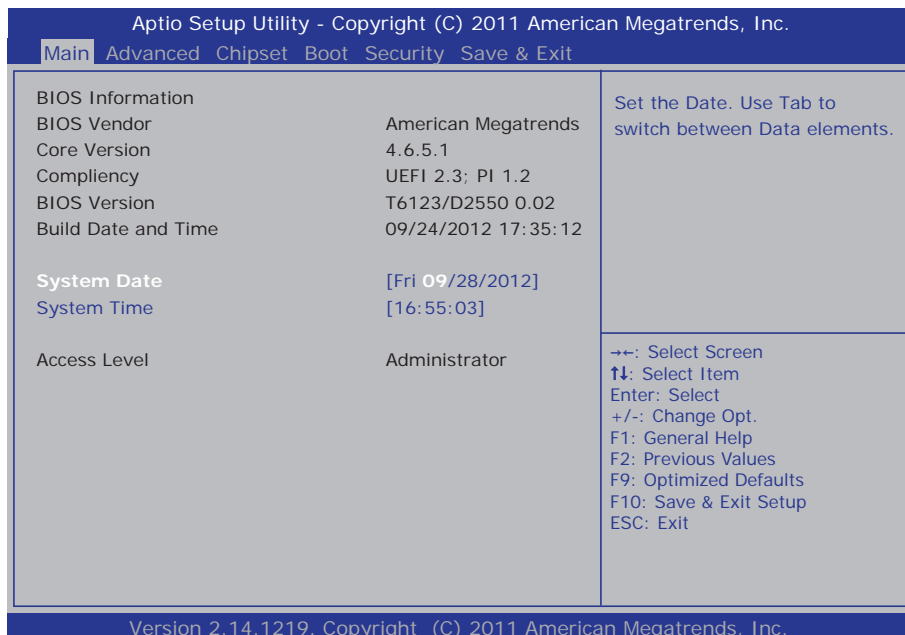

The featured settings are:

Setting	Description
<b>System Time</b>	Sets system time. ► The time format is: <b>Hour:</b> 00 to 23 <b>Minute:</b> 00 to 59 <b>Second:</b> 00 to 59
<b>System Date</b>	Sets system date. ► The date format is: <b>Day:</b> Sun to Sat <b>Month:</b> 1 to 12 <b>Date:</b> 1 to 31 <b>Year:</b> 1999 to 2099

## 5.2. Advanced

The **Advanced** menu configures the system’s Super IO chip.

For Models with Intel® Celeron® 827E, please refer to the following picture.

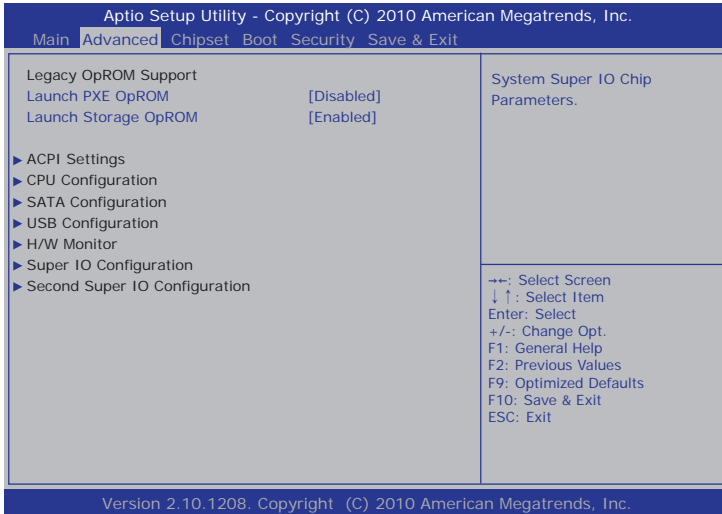

For Models with Intel® Atom™ D2550, please refer to the following picture.

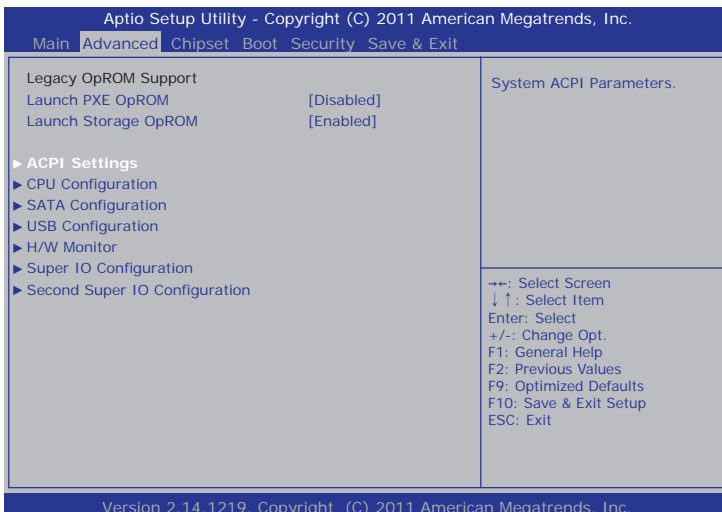

The featured settings and submenus are:

Setting	Description
Launch PXE OpROM	Enables/disables the boot option for legacy network devices. ▶ <b>Disabled</b> is the default.
Launch Storage OpROM	Enables/disables the boot option for legacy mass storage devices with Option ROM. ▶ <b>Enabled</b> is the default.
ACPI Settings	See <a href="#">5.2.1. ACPI Settings</a> on page <a href="#">75</a> .
CPU Configuration	See <a href="#">5.2.2. CPU Configuration</a> on page <a href="#">76</a> .
SATA Configuration	See <a href="#">5.2.3. SATA Configuration</a> on page <a href="#">76</a> .
USB Configuration	See <a href="#">5.2.4. USB Configuration</a> on page <a href="#">76</a> .
H/W Monitor	See <a href="#">5.2.5. H/W Monitor</a> on page <a href="#">77</a> .
Super IO Configuration	See <a href="#">5.2.6. Super IO Configuration</a> on page <a href="#">77</a> .
Second Super IO Configuration	See <a href="#">5.2.7. Second Super IO Configuration</a> on page <a href="#">77</a> .

### 5.2.1. ACPI Settings

**ACPI Settings** configure the system's ACPI. The featured settings are:

Setting	Description
Enable Hibernation	Enables/disables the system to/from hibernation (OS/S4 Sleep State). ▶ <b>Enabled</b> is the default. ▶ This option may not be effective with some OS.
ACPI Sleep State	Sets the highest ACPI sleep state that system enters when the suspend button is hit. ▶ Options available are <b>S1 (CPU Stop Clock)</b> and <b>Suspend Disabled</b> . ▶ <b>S1 (CPU Stop Clock)</b> is the default.
Power-Supply Type	Sets the power-supply type. ▶ Options available are <b>AT</b> (default) and <b>ATX</b> .

### 5.2.2. CPU Configuration

Select **CPU Configuration** to view the CPU parameters such as the model name, processor stepping, processor speed, microcode revision, max. processor speed, min. processor speed, processor cores, Intel HT Technology and EMT64 support.

### 5.2.3. SATA Configuration

**SATA Configuration** delivers SATA device(s) information and provides users with the settings to control SATA device. Featured settings are:

Setting	Description
<b>SATA Controller(s)</b>	Enables/disables SATA device. ▶ <b>Enabled</b> is the default.
<b>SATA Mode Selection</b>	Sets how SATA controller(s) operate. ▶ Options available are <b>IDE</b> (default) and <b>AHCI</b> .
<b>SATA Port #</b> (Atom D2550 Only)	Enables/disables the specified SATA port. ▶ <b>Enabled</b> is the default.
<b>SATA Port # Hot Plug</b> (Atom D2550 Only)	Sets the specified SATA port to hot pluggable. ▶ <b>Enabled</b> is the default.

### 5.2.4. USB Configuration

**USB Configuration** displays the info of the connected USB devices and sets USB parameters. The featured setting is:

Setting	Description
<b>Legacy USB Support</b>	Enables/disables legacy USB support. ▶ Options available are <b>Enabled</b> (default), <b>Disabled</b> and <b>Auto</b> . ▶ Select <b>Auto</b> to disable legacy support if no USB device are connected. ▶ Select <b>Disabled</b> to keep USB devices available only for EFI applications.

### 5.2.5. H/W Monitor

**H/W Monitor** monitors the systems' hardware status. Select **H/W Monitor** to run a health report of the IPPC that includes the info of CPU temperature, system temperature, VCC, VCORE and so on.

### 5.2.6. Super IO Configuration

**Super IO Configuration** controls the system's Super IO chip. The featured setting is:

Setting	Description
<b>Power On After Power Fail</b>	Defines which state to go to when power is resumed after a power failure. <ul style="list-style-type: none"> <li>Options available are <b>Power Off</b> (default) and <b>Power On</b>.</li> </ul>

### 5.2.7. Second Super IO Configuration

**Second Super IO Configuration** sets the parameters for the serial port(s) available on the system. The featured settings are:

Setting	Description						
<b>Serial Port 1 Configuration</b>	The following settings are featured for the specified serial port:						
	<table border="1"> <thead> <tr> <th>Setting</th> <th>Description</th> </tr> </thead> <tbody> <tr> <td><b>Serial Port</b></td> <td>           Enables/disables the serial port (COM).           <ul style="list-style-type: none"> <li><b>Enabled</b> is the default.</li> </ul> </td> </tr> <tr> <td><b>Change Settings</b></td> <td>           Sets the optimal IO address and IRQ info for the Super IO device.           <ul style="list-style-type: none"> <li>Options available are:               <ul style="list-style-type: none"> <li><b>IO=3F8h; IRQ=4;</b> (default)</li> <li><b>IO=3F8h; IRQ=3,4,5,6,7,9,10,11,12;</b></li> <li><b>IO=2F8h; IRQ=3,4,5,6,7,9,10,11,12;</b></li> <li><b>IO=3E8h; IRQ=3,4,5,6,7,9,10,11,12;</b></li> <li><b>IO=2E8h; IRQ=3,4,5,6,7,9,10,11,12;</b></li> </ul> </li> </ul> </td> </tr> </tbody> </table>	Setting	Description	<b>Serial Port</b>	Enables/disables the serial port (COM). <ul style="list-style-type: none"> <li><b>Enabled</b> is the default.</li> </ul>	<b>Change Settings</b>	Sets the optimal IO address and IRQ info for the Super IO device. <ul style="list-style-type: none"> <li>Options available are:               <ul style="list-style-type: none"> <li><b>IO=3F8h; IRQ=4;</b> (default)</li> <li><b>IO=3F8h; IRQ=3,4,5,6,7,9,10,11,12;</b></li> <li><b>IO=2F8h; IRQ=3,4,5,6,7,9,10,11,12;</b></li> <li><b>IO=3E8h; IRQ=3,4,5,6,7,9,10,11,12;</b></li> <li><b>IO=2E8h; IRQ=3,4,5,6,7,9,10,11,12;</b></li> </ul> </li> </ul>
	Setting	Description					
<b>Serial Port</b>	Enables/disables the serial port (COM). <ul style="list-style-type: none"> <li><b>Enabled</b> is the default.</li> </ul>						
<b>Change Settings</b>	Sets the optimal IO address and IRQ info for the Super IO device. <ul style="list-style-type: none"> <li>Options available are:               <ul style="list-style-type: none"> <li><b>IO=3F8h; IRQ=4;</b> (default)</li> <li><b>IO=3F8h; IRQ=3,4,5,6,7,9,10,11,12;</b></li> <li><b>IO=2F8h; IRQ=3,4,5,6,7,9,10,11,12;</b></li> <li><b>IO=3E8h; IRQ=3,4,5,6,7,9,10,11,12;</b></li> <li><b>IO=2E8h; IRQ=3,4,5,6,7,9,10,11,12;</b></li> </ul> </li> </ul>						

<b>Serial Port 2 Configuration</b>	The following settings are featured for the specified serial port:	
	<b>Setting</b>	<b>Description</b>
	<b>Serial Port</b>	Enables/disables the serial port (COM). ▶ <b>Enabled</b> is the default.
<b>Change Settings</b>	Sets the optimal IO address and IRQ info for the Super IO device. ▶ Options available are: <b>IO=2F8h; IRQ=3;</b> (default) <b>IO=3F8h; IRQ=3,4,5,6,7,9,10,11,12;</b> <b>IO=2F8h; IRQ=3,4,5,6,7,9,10,11,12;</b> <b>IO=3E8h; IRQ=3,4,5,6,7,9,10,11,12;</b> <b>IO=2E8h; IRQ=3,4,5,6,7,9,10,11,12;</b>	
<b>Serial Port 3 Configuration</b>	The following settings are featured for the specified serial port:	
	<b>Setting</b>	<b>Description</b>
	<b>Serial Port</b>	Enables/disables the serial port (COM). ▶ <b>Enabled</b> is the default.
<b>Change Settings</b>	Sets the optimal IO address and IRQ info for the Super IO device. ▶ Options available are: <b>IO=3E8h; IRQ=10;</b> (default) <b>IO=3F8h; IRQ=3,4,5,6,7,9,10,11,12;</b> <b>IO=2F8h; IRQ=3,4,5,6,7,9,10,11,12;</b> <b>IO=3E8h; IRQ=3,4,5,6,7,9,10,11,12;</b> <b>IO=2E8h; IRQ=3,4,5,6,7,9,10,11,12;</b>	
<b>Serial Port 4 Configuration</b>	The following settings are featured for the specified serial port:	
	<b>Setting</b>	<b>Description</b>
	<b>Serial Port</b>	Enables/disables the serial port (COM). ▶ <b>Enabled</b> is the default.
<b>Change Settings</b>	Sets the optimal IO address and IRQ info for the Super IO device. ▶ Options available are: <b>IO=2E8h; IRQ=11;</b> (default) <b>IO=3F8h; IRQ=3,4,5,6,7,9,10,11,12;</b> <b>IO=2F8h; IRQ=3,4,5,6,7,9,10,11,12;</b> <b>IO=3E8h; IRQ=3,4,5,6,7,9,10,11,12;</b> <b>IO=2E8h; IRQ=3,4,5,6,7,9,10,11,12;</b>	



### 5.3. Chipset

The **Chipset** menu controls the system's chipset.

For Models with Intel® Celeron® 827E, please refer to the following picture.

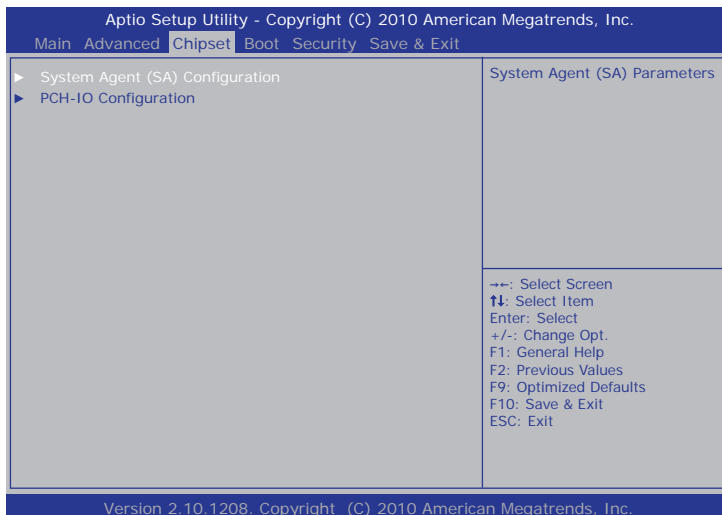

The featured submenu are **System Agent (SA) Configuration** and **PCH-IO Configuration**, which are covered in the following sections.

Submenu	Description
<b>System Agent (SA) Configuration</b>	See <a href="#">5.3.1. System Agent (SA) Configuration</a> on page <a href="#">80</a> .
<b>PCH-IO Configuration</b>	See <a href="#">5.3.2. PCH-IO Configuration</a> on page <a href="#">85</a> .

For Models with Intel® Atom™ D2550, please refer to the following picture.

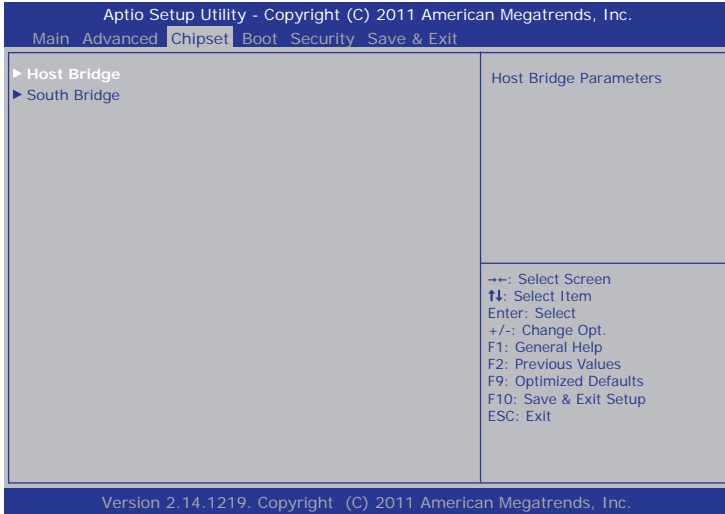

The featured submenus are **Host Bridge** and **South Bridge**, which are covered in the following sections.

Submenu	Description
<b>Host Bridge</b>	This is a submenu to feature the settings for host bridge. See <a href="#">5.3.3. Host Bridge</a> on page <a href="#">86</a> .
<b>South Bridge</b>	This is a submenu to feature the settings for south bridge. See <a href="#">5.3.4. South Bridge</a> on page <a href="#">88</a> .

### 5.3.1. System Agent (SA) Configuration

This submenu shows and configures System Agent (SA) settings. The featured settings are:

Setting	Description
<b>Graphic Configuration</b>	See <a href="#">5.3.1.1. Graphic Configuration</a> on page <a href="#">81</a> .
<b>DMI Configuration</b>	See <a href="#">5.3.1.2. DMI Configuration</a> on page <a href="#">84</a> .
<b>NB PCIe Configuration</b>	See <a href="#">5.3.1.3. NB PCIe Configuration</a> on page <a href="#">84</a> .
<b>Memory Configuration</b>	See <a href="#">5.3.1.4. Memory Configuration</a> on page <a href="#">85</a> .

### 5.3.1.1. Graphic Configuration

Select **Graphic Configuration** to view graphics info and accesses graphic settings. The featured settings are:

Setting / Submenu	Description	
<b>Graphics Turbo IMON Current</b>	Sets the graphic turbo IMON current values. <ul style="list-style-type: none"> <li>Options available are <b>14</b> to <b>31</b>.</li> <li><b>31</b> is the default.</li> </ul>	
<b>Primary Display</b>	Sets which graphics device to use as the primary display or sets <b>SG</b> for switchable Gfx. <ul style="list-style-type: none"> <li>Options available are <b>Auto</b> (default), <b>IGFX</b>, <b>PEG</b>, <b>PCI</b> and <b>SG</b>.</li> </ul>	
<b>Internal Graphics</b>	Enables/disables the internal graphic device. <ul style="list-style-type: none"> <li>Options available are <b>Auto</b> (default), <b>Enabled</b> and <b>Disabled</b>.</li> </ul>	
<b>LCD Control</b>	Configures LCD settings. Options available are:	
	Setting	Description
	<b>Primary IGFX Boot Display</b>	See <a href="#">Primary IGF Boot Display</a> on page 82.
	<b>LCD Panel Type</b>	See <a href="#">LCD Panel Type</a> on page 82.
	<b>Panel Scaling</b>	See <a href="#">Panel Scaling</a> on page 82.
	<b>Backlight Control</b>	See <a href="#">Backlight Control</a> on page 82.
	<b>BIA</b>	See <a href="#">BIA</a> on page 83.
	<b>Spread Spectrum clock Chip</b>	See <a href="#">Spread Spectrum clock Chip</a> on page 83.
	<b>ALS Support</b>	See <a href="#">ALS Support</a> on page 83.
<b>Active LFP</b>	See <a href="#">Active LFP</a> on page 83.	
<b>Panel Color Depth</b>	See <a href="#">Panel Color Depth</a> on page 84.	

## Primary IGF Boot Display

Sets the video device to activate during POST.

- ▶ Options available are **CRT**, **LVDS** and **CRT + LVDS** (default).
- ▶ This setting has no effect if an external graphics card is present.
- ▶ Secondary boot display selection will appear based on your selection.
- ▶ VGA modes are supported only on primary display.

## LCD Panel Type

Sets the LCD panel types. Options available are:

**VBIOS Default**  
**800x600 LVDS**  
**1024x768 LVDS** (default)  
**1280x1024 LVDS**  
**1400x1050 LVDS1**  
**1400x1050 LVDS2**  
**1600x1200 LVDS**  
**1680x1050 LVDS**  
**1920x1200 LVDS**  
**1600x900 LVDS**  
**1280x800 LVDS**  
**1280x600 LVDS**  
**2048x1536 LVDS**  
**1366x768 LVDS**

## Panel Scaling

Sets the LCD panel scaling for the internal graphic. Options available are **Auto** (default), **Off** and **Force Scaling**.

## Backlight Control

Configures LCD backlight. Options available are **PWM Inverted** (default), **PWM Normal**, **GMBus Inverted**, and **GMBus Normal**.

## BIA

Enables/disables Backlight Image Adaptation control.

- ▶ Options available are **Auto** (default), **Disabled** and **Level 1~5**.
- ▶ Select **Auto** to have **GMCH** backlight control use VBT default.
- ▶ Select **Level 1~5** to enable BIA control with different aggressiveness.

## Spread Spectrum clock Chip

Sets which hardware / software to control the spread spectrum.

- ▶ Options available are **Off** (default), **Hardware** and **Software**.
- ▶ Select **Hardware** to control the spread spectrum by the chip.
- ▶ Select **Software** to control the spread spectrum by the BIOS.

## ALS Support

Enables/disables ALS support.

- ▶ This setting is only efficacious for ACPI.
- ▶ For legacy, ALS is supported through the internal graphic device INT10 function.
- ▶ For ACPI, ALS is supported through an ACPI ALS driver.

## Active LFP

Configures LFP.

- ▶ Select **No LVDS** to have VBIOS disable LVDS.
- ▶ Select **Int-LVDS** to have BIOS enable LVDS driver by the integrated encoder. (Default.)
- ▶ Select **SDVO LVDS** to have VBIOS enable LVDS driver by SDVO encoder.
- ▶ Select **eDP Port-A** to drive LFP by the **Int-DisplayPort** encoder from Port-A.
- ▶ Select **eDP Port-D** to drive LFP by the **Int-DisplayPort** encoder from Port-D.

## Panel Color Depth

Sets the color depth for LFP panel.

- ▶ Options available are **18 Bit** and **24 Bit**.

### 5.3.1.2. DMI Configuration

Use this submenu to control various DMI features.

### 5.3.1.3. NB PCIe Configuration

Configures NB PCI Express. Featured settings are:

Setting	Description
PEG0 - Gen X	Configures PEG0 B0:D1:F0 Gen1-Gen2. ▶ Options available are <b>Gen1</b> (default) and <b>Gen2</b> .
PEG1 - Gen X	Configures PEG1 B0:D1:F1 Gen1-Gen2. ▶ Options available are <b>Gen1</b> (default) and <b>Gen2</b> .
PEG2 - Gen X	Configures PEG2 B0:D1:F2 Gen1-Gen2. ▶ Options available are <b>Gen1</b> (default) and <b>Gen2</b> .
PEG3 - Gen X	Configures PEG3 B0:D1:F3 Gen1-Gen2. ▶ Options available are <b>Gen1</b> (default) and <b>Gen2</b> .
Always Enable PEG	Enables/disables the PEG slot. ▶ <b>Enabled</b> is the default.
PEG ASPM	Sets ASPM support for the PEG device. ▶ This setting is inefficacious if PEG isn't active at the moment. ▶ Options available are: <b>Disabled</b> , <b>Auto</b> (default), <b>ASPM L0s</b> , <b>ASPM L1</b> and <b>ASPM L0sL1</b> .
De-emphasis Control	Configures the De-emphasis control on PEG. ▶ Options available are: <b>-6 dB</b> and <b>-3.5 dB</b> (default).

### 5.3.1.4. Memory Configuration

Select **Memory Configuration** to view the system's memory information that includes memory RC version, memory frequency, total memory, DIMM presence, CAS latency and minimum delay time.

### 5.3.2. PCH-IO Configuration

**PCH-IO Configuration** sets PCH parameters. Featured settings are:

Setting / Submenu	Description						
<b>PCH LAN Controller</b>	Enables/disables the onboard NIC (network interface controller). ▶ <b>Enabled</b> is the default.						
<b>Wake on LAN</b>	Enables/disables the integrated LAN to wake the system. ▶ <b>Enabled</b> is the default.						
<b>PCIE Wake Up</b>	Enables/disables PCIE Wake# to wake the system. ▶ <b>Disabled</b> is the default.						
<b>Azalia</b>	Enables/disables Intel High Definition Audio. ▶ "Azalia" is the codename for Intel's High Definition Audio during development stage. ▶ Select <b>Disabled</b> to unconditionally disable Azalia ▶ Select <b>Enabled</b> to unconditionally enable Azalia. ▶ Select <b>Auto</b> to enable Azalia if it is present and to disable it if otherwise.						
<b>USB Configuration</b>	Controls USB devices. Featured settings are: <table border="1"> <thead> <tr> <th>Setting</th> <th>Description</th> </tr> </thead> <tbody> <tr> <td><b>EHCI1</b></td> <td>Enables/disables the USB EHCI (USB2.0) functions. ▶ <b>Enabled</b> is the default. ▶ One EHCI controller must always be enabled.</td> </tr> <tr> <td><b>EHCI2</b></td> <td>Enables/disables the USB EHCI (USB2.0) functions. ▶ <b>Enabled</b> is the default. ▶ One EHCI controller must always be enabled.</td> </tr> </tbody> </table>	Setting	Description	<b>EHCI1</b>	Enables/disables the USB EHCI (USB2.0) functions. ▶ <b>Enabled</b> is the default. ▶ One EHCI controller must always be enabled.	<b>EHCI2</b>	Enables/disables the USB EHCI (USB2.0) functions. ▶ <b>Enabled</b> is the default. ▶ One EHCI controller must always be enabled.
Setting	Description						
<b>EHCI1</b>	Enables/disables the USB EHCI (USB2.0) functions. ▶ <b>Enabled</b> is the default. ▶ One EHCI controller must always be enabled.						
<b>EHCI2</b>	Enables/disables the USB EHCI (USB2.0) functions. ▶ <b>Enabled</b> is the default. ▶ One EHCI controller must always be enabled.						

### 5.3.3. Host Bridge

This submenu opens showing the memory information such as memory frequency, total memory and the memory module(s) connected. This submenu also features one submenu - **Intel IGD Configuration** to configure Intel IGD (Internal Graphics Device) by the following settings:

Setting	Description
<b>Auto Disable IGD</b>	Sets whether to auto-disable the internal graphics device upon detecting any external one. <ul style="list-style-type: none"> <li>Options available are <b>Disabled</b> and <b>Enabled</b> (default).</li> </ul>
<b>IGFX - Boot Type</b>	Sets the video device to activate during POST. <ul style="list-style-type: none"> <li>This setting has no effect if an external graphics device is detected.</li> <li>Options available are <b>CRT</b>, <b>LVDS</b> (default) and <b>DVI</b>.</li> </ul>
<b>LCD Panel Type</b>	Sets the type of the LCD panel for the internal graphics device to use. <ul style="list-style-type: none"> <li>Options available are:                             <ul style="list-style-type: none"> <li><b>640x480 LVDS</b></li> <li><b>800x600 LVDS</b></li> <li><b>1024x768 LVDS</b> (default)</li> <li><b>1280x1024 LVDS</b></li> <li><b>1366x768 LVDS</b></li> <li><b>1366x768 24bit LVDS</b></li> <li><b>1024x600 LVDS</b></li> <li><b>1280x800 LVDS</b></li> <li><b>1024x768 24bit LVDS</b></li> </ul> </li> </ul>
<b>Panel Scaling</b>	Sets the LCD panel scaling for the internal graphics device. <ul style="list-style-type: none"> <li>Options available are <b>Auto</b> (default), <b>Force Scaling</b>, <b>Off</b> and <b>Maintain Aspect Ratio</b>.</li> </ul>
<b>Backlight Control</b>	Sets LCD backlight. <ul style="list-style-type: none"> <li>Options available are <b>PWM Inverted</b>, <b>GMBus Inverted</b>, <b>PWM Normal</b> (default) and <b>GMBus Normal</b>.</li> </ul>



<b>IGD Clock Source</b>	Sets the IGD clock to use. <ul style="list-style-type: none"> <li>▶ Options available are <b>External Clock</b> (default) and <b>Internal Clock</b>.</li> </ul>
<b>Fixed Graphics Memory Size</b>	Sets the fixed graphics memory size. <ul style="list-style-type: none"> <li>▶ Options available are <b>128MB</b> (default) and <b>256MB</b>.</li> </ul>
<b>ALS Support</b>	Enables/disables ALS (ambient light sensor) support. <ul style="list-style-type: none"> <li>▶ This setting is only effective for ACPI.</li> <li>▶ For legacy, ALS is supported through the internal graphic device INT10 function.</li> <li>▶ For ACPI, ALS is supported through an ACPI ALS driver.</li> </ul>
<b>Backlight Control Support</b>	Sets the backlight control features. <ul style="list-style-type: none"> <li>▶ This setting isn't available when <b>IGFX-Boot Type</b> is set to <b>CRT</b>.</li> <li>▶ Options available are <b>VBIOS-Default</b> (default), <b>BLC&amp;BIA Disabled</b> and <b>BLC Enabled</b>.</li> <li>▶ BLC means "Backlight Compensation" and BIA "Backlight Image Adaptation".</li> </ul>
<b>BIA</b>	Sets the aggressiveness of BIA (Backlight Image Adaption) or disables it. <ul style="list-style-type: none"> <li>▶ This setting isn't available when <b>IGFX-Boot Type</b> is set to <b>CRT</b>.</li> <li>▶ Options available are:  <b>Auto</b> (default)  <b>Disabled</b>  <b>Level 1</b>  <b>Level 2</b>  <b>Level 3</b>  <b>Level 4</b>  <b>Level 5</b> </li> </ul>

### 5.3.4. South Bridge

The submenu **South Bridge** configures the south bridge features by the following setting and submenu:

Setting / Submenu	Description				
<b>TPT Device</b>	This is a submenu to control Intel® IO Controller Hub (TPT), which connects and controls peripheral devcies. The featured settings are:				
	<table border="1"> <thead> <tr> <th data-bbox="297 496 530 523">Setting</th> <th data-bbox="535 496 999 523">Description</th> </tr> </thead> <tbody> <tr> <td data-bbox="297 529 530 745"> <b>Azalia Controller</b> </td> <td data-bbox="535 529 999 745">                             Enables/disables Intel High Definition Audio.                             <ul style="list-style-type: none"> <li>▶ “Azalia” is the codename for Intel’s High Definition Audio during development stage.</li> <li>▶ Options available are <b>Disabled</b> and <b>HD audio</b> (default).</li> </ul> </td> </tr> </tbody> </table>	Setting	Description	<b>Azalia Controller</b>	Enables/disables Intel High Definition Audio. <ul style="list-style-type: none"> <li>▶ “Azalia” is the codename for Intel’s High Definition Audio during development stage.</li> <li>▶ Options available are <b>Disabled</b> and <b>HD audio</b> (default).</li> </ul>
	Setting	Description			
	<b>Azalia Controller</b>	Enables/disables Intel High Definition Audio. <ul style="list-style-type: none"> <li>▶ “Azalia” is the codename for Intel’s High Definition Audio during development stage.</li> <li>▶ Options available are <b>Disabled</b> and <b>HD audio</b> (default).</li> </ul>			
<b>Select USB Mode</b>	Sets how to control USB ports. <ul style="list-style-type: none"> <li>▶ Options available are <b>By Ports</b> and <b>By Controllers</b> (default).</li> <li>▶ Selecting <b>By Ports</b> and <b>By Controller</b> will open different sub-settings. See <a href="#">5.3.1.2. DMI Configuration</a> and <a href="#">5.3.1.3. NB PCIe Configuration</a> for details.</li> </ul>				
<b>USB 2.0 (EHCI) Support</b>	Enables/disables USB 2.0 (EHCI) functions for the specified ports. <ul style="list-style-type: none"> <li>▶ Options available are <b>Disabled</b> and <b>Enabled</b> (default).</li> </ul>				

 Sets the minimum assertion width of the SLP\_S4# signal to ensure the DRAMs have been safely power-cycled.    - ▶ Options available are:   - 1-2 Seconds** (default)   - 2-3 Seconds**   - 3-4 Seconds**   - 4-5 Seconds** |

### 5.3.4.1. Selecting By Ports

When **Select USB Mode** is set to **By Ports**, the following setting becomes available:

Setting	Description
<b>USB Function</b>	<p>Enables a certain number of ports for USB function or disables them all.</p> <ul style="list-style-type: none"> <li>▶ This setting is only available when <b>Select USB Mode</b> is set to <b>By Ports</b>.</li> <li>▶ Options available are: <ul style="list-style-type: none"> <li><b>Disabled</b></li> <li><b>1 USB Ports</b></li> <li><b>2 USB Ports</b></li> <li><b>3 USB Ports</b></li> <li><b>4 USB Ports</b></li> <li><b>5 USB Ports</b></li> <li><b>6 USB Ports</b></li> <li><b>7 USB Ports</b></li> <li><b>8 USB Ports (default)</b></li> </ul> </li> </ul>

### 5.3.4.2. Selecting By Controllers

When **Select USB Mode** is set to **By Controllers**, the following settings are available:

Setting	Description
<b>UHCI #1 (ports 0 and 1)</b>	<p>Enables/disables USB 1.1 (UHCI) functions for the specified ports.</p> <ul style="list-style-type: none"> <li>▶ This setting is only available when <b>Select USB Mode</b> is set to <b>By Controllers</b>.</li> <li>▶ Options available are <b>Disabled</b> and <b>Enabled (default)</b>.</li> </ul>
<b>UHCI #2 (ports 2 and 3)</b>	
<b>UHCI #3 (ports 4 and 5)</b>	
<b>UHCI #4 (ports 6 and 7)</b>	

**By Controllers** is also the default setting for **Select USB Mode**.

## 5.4. Boot

The **Boot** menu configures how to boot up the system such as boot device priority.

For Models with Intel® Celeron® 827E, please refer to the following picture.

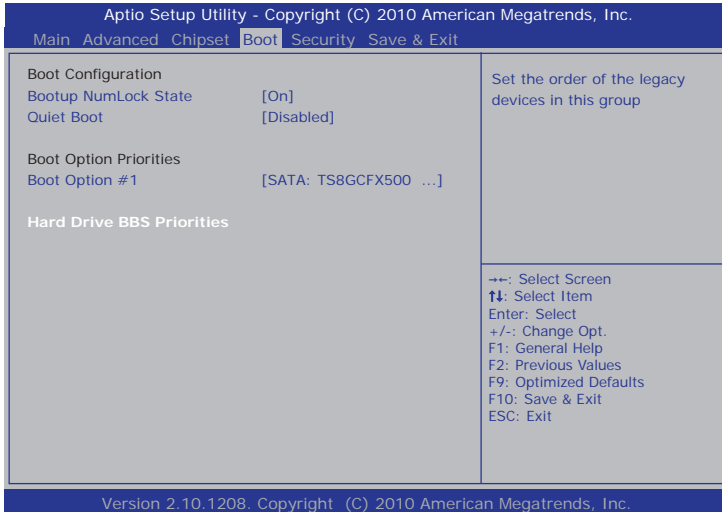

For Models with Intel® Atom™ D2550, please refer to the following picture.

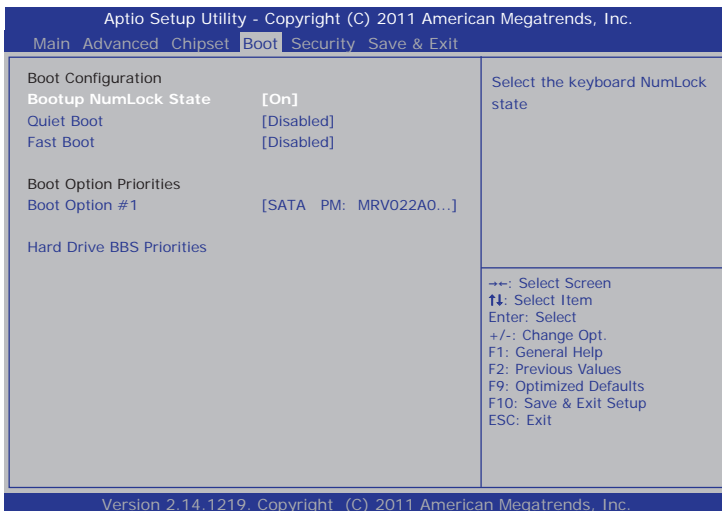

The featured settings are:

Setting	Description
<b>Bootup NumLock State</b>	<p>Sets keyboard's NumLock state when the system boots up.</p> <ul style="list-style-type: none"> <li>▶ Options available are <b>On</b> (default) and <b>Off</b>.</li> </ul>
<b>Quiet Boot</b>	<p>Sets whether to display the POST (power on self tests) messages or the system manufacturer's full screen logo during booting.</p> <ul style="list-style-type: none"> <li>▶ Select <b>Disabled</b> to display the normal POST messages, which is the default setting.</li> </ul>
<b>Fast Boot</b> (Atom D2550 Only)	<p>Enables/disables booting with the initialization of a minimal set of devices required to launch active boot options.</p> <ul style="list-style-type: none"> <li>▶ This setting has no effect on BBS (BIOS Boot Specification), which is a plug and play BIOS format that enables the system to boot from a network device or a SCSI adapter for which BIOS has no driver code.</li> <li>▶ <b>Disabled</b> is the default.</li> </ul>
<b>Boot Option #1</b>	<p>Sets the very 1st boot device.</p> <ul style="list-style-type: none"> <li>▶ Options available are the built-in <b>SATA: TS8GCFX500</b> (default) and <b>Disabled</b>.</li> </ul>
<b>Hard Drive BBS Priority</b>	<p>Sets hard drive boot priority.</p> <ul style="list-style-type: none"> <li>▶ Options available are the built-in hard drive (the default) and <b>Disabled</b>.</li> </ul>

## 5.5. Security

The **Security** menu sets up the administrator password. Once an administrator password is set up, this BIOS SETUP utility is limited to access and will ask for the password each time any access is attempted.

For Models with Intel® Celeron® 827E, please refer to the following picture.

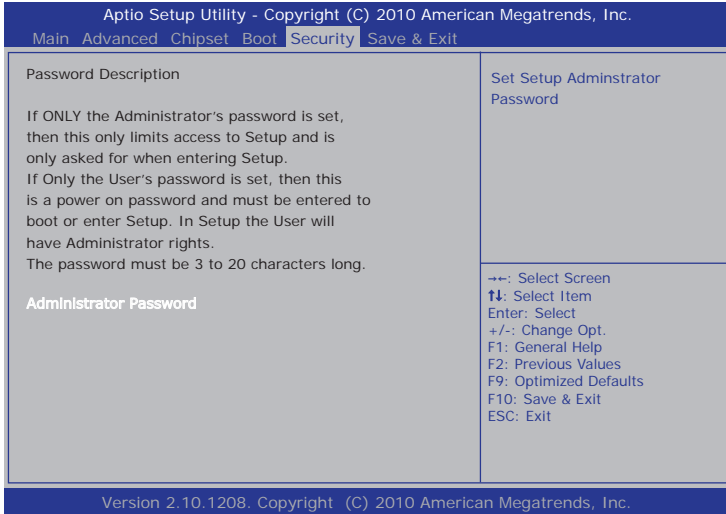

For Models with Intel® Atom™ D2550, please refer to the following picture.

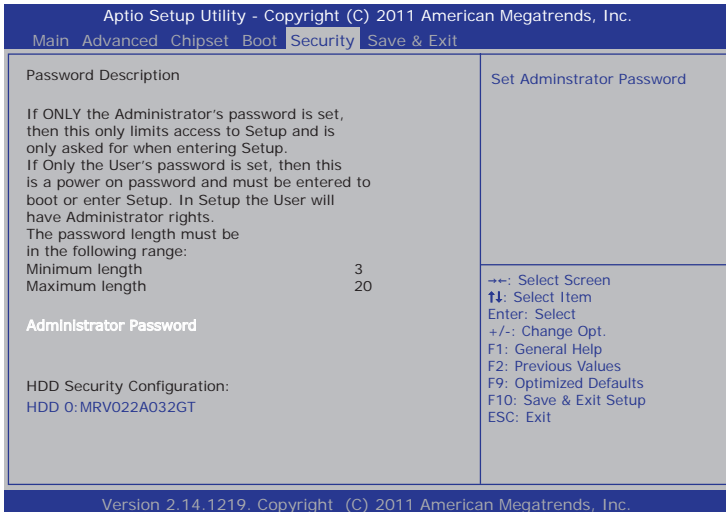

The featured setting is:

Setting	Description						
<b>Administrator Password</b>	<p>To set up an administrator password:</p> <ol style="list-style-type: none"> <li>1. Select <b>Administrator Password</b>. The screen then pops up an <b>Create New Password</b> dialog.</li> <li>2. Enter your desired password that is no less than 3 characters and no more than 20 characters.</li> <li>3. Hit [Enter] key to submit.</li> </ol>						
<b>HDD Security Configuration: HDD 0:MRV022A032GT</b>	<p>Sets up each user password and master password for the security of hard disk drive(s). The featured settings are:</p> <table border="1"> <thead> <tr> <th>Setting</th> <th>Description</th> </tr> </thead> <tbody> <tr> <td><b>Set User Password</b></td> <td> <p>Sets up an user password that limits unauthorized access to the HDD.</p> <ul style="list-style-type: none"> <li>▶ The password must be no less than 3 characters and no more than 20 characters.</li> </ul> </td> </tr> <tr> <td><b>Set Master Password</b></td> <td> <p>Sets up a master password that can remove the user password.</p> <ul style="list-style-type: none"> <li>▶ The password must be no less than 3 characters and no more than 20 characters.</li> </ul> </td> </tr> </tbody> </table>	Setting	Description	<b>Set User Password</b>	<p>Sets up an user password that limits unauthorized access to the HDD.</p> <ul style="list-style-type: none"> <li>▶ The password must be no less than 3 characters and no more than 20 characters.</li> </ul>	<b>Set Master Password</b>	<p>Sets up a master password that can remove the user password.</p> <ul style="list-style-type: none"> <li>▶ The password must be no less than 3 characters and no more than 20 characters.</li> </ul>
Setting	Description						
<b>Set User Password</b>	<p>Sets up an user password that limits unauthorized access to the HDD.</p> <ul style="list-style-type: none"> <li>▶ The password must be no less than 3 characters and no more than 20 characters.</li> </ul>						
<b>Set Master Password</b>	<p>Sets up a master password that can remove the user password.</p> <ul style="list-style-type: none"> <li>▶ The password must be no less than 3 characters and no more than 20 characters.</li> </ul>						

## 5.6. Save & Exit

The **Save & Exit** menu features a handful of commands to launch actions from the BIOS SETUP utility regarding saving changes, quitting the utility and recovering defaults.

For Models with Intel® Celeron® 827E, please refer to the following picture.

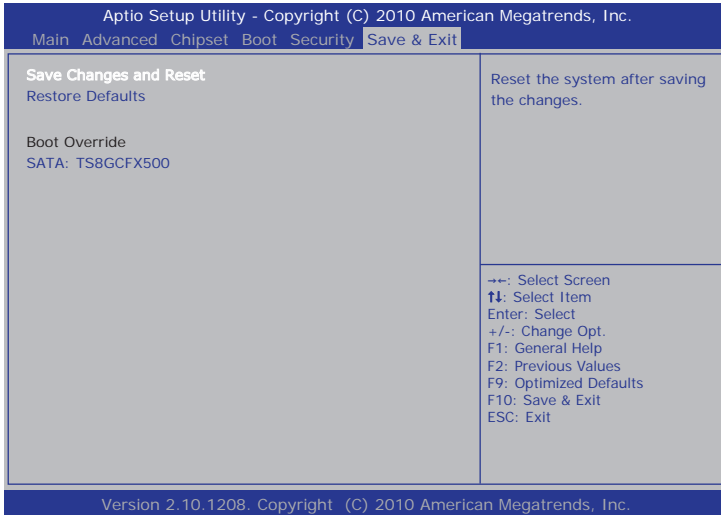

For Models with Intel® Atom™ D2550, please refer to the following picture.

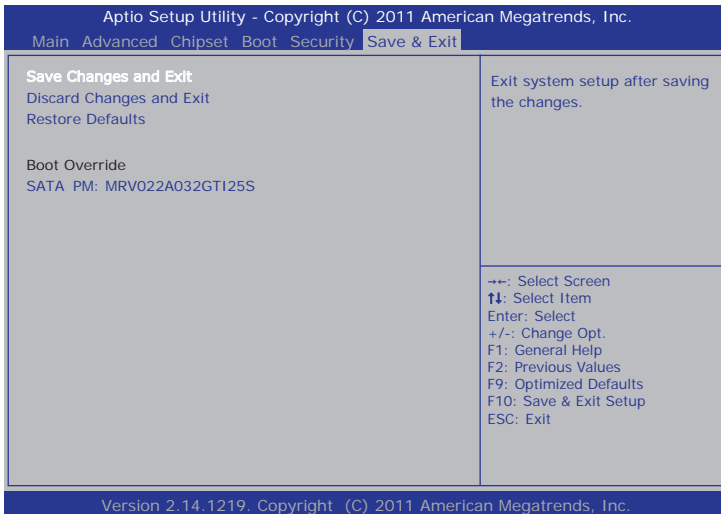



Features settings are:

Setting	Description
<b>Save Changes and Reset</b>	Saves the changes and resets the system. <ul style="list-style-type: none"><li>▶ This is a command to launch action from the BIOS SETUP utility.</li></ul>
<b>Discards Changes and Exit</b> (Atom D2550 Only)	Discards the changes and quits the BIOS SETUP utility. <ul style="list-style-type: none"><li>▶ This is a command to launch an action from the BIOS SETUP utility.</li></ul>
<b>Restore Defaults</b>	Restores the factory defaults. <ul style="list-style-type: none"><li>▶ This is a command to launch action from the BIOS SETUP utility.</li></ul>
<b>Boot Override</b>	<b>Boot Override</b> presents a list of boot devices onscreen. Select the device to boot up the system regardless of the currently configured boot priority. <ul style="list-style-type: none"><li>▶ This is a command to launch action from the BIOS SETUP utility.</li></ul>

---

# Appendix

## Touch Panel

## 1. PenMount Monitor

The PenMount Monitor icon (pm) will appear in the system tray at the bottom-right corner after you turn on **PenMount Monitor** from **Programs/ PenMount Universal Driver/ PenMount Monitor**. Right-click the pm icon in system tray and display its submenu.

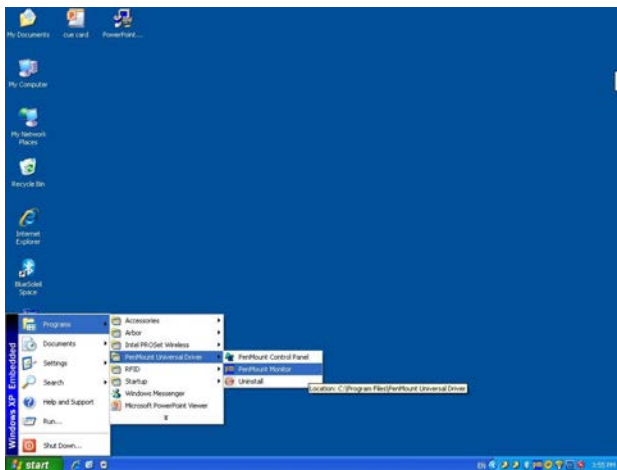
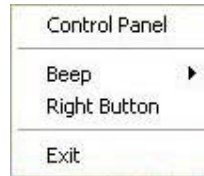

PenMount Monitor has the following functions:

<b>Control Panel</b>	Launch the <b>PenMount Control Panel</b> utility. You may also launch it from <b>Programs</b> .
<b>Beep</b>	Set the Beep function for each device.
<b>Right Button</b>	After ticking this item, a mouse icon  appears on the right side of your screen.
<b>Exit</b>	Exits the PenMount Monitor function.

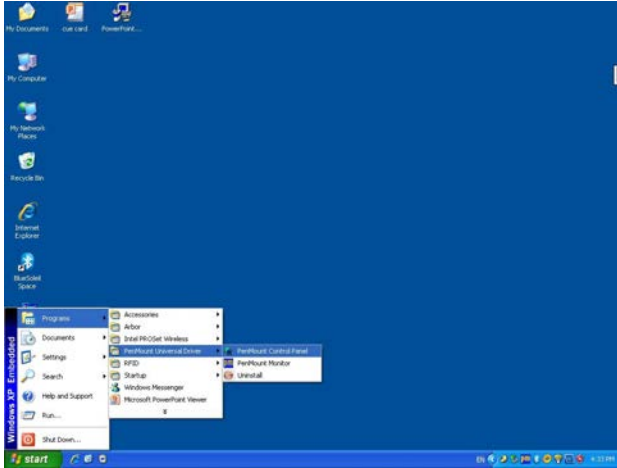

## 2. PenMount Control Panel

After you have selected the **Control Panel** item on the pop-up menu or open it up from **Programs** (as shown on previous page), the PenMount Control Panel utility UI appears as below. The functions of the **PenMount Control Panel** such as Device, Calibrate, Setting, Multiple Monitors, Tools and About are explained in the following sections.

### The Tools Tab

When you click the PenMount icon in the system tray and select "Control Panel" from the menu, "PenMount Control Panel" will appear. Among the four tabs - Device, Multiple Monitors, **Tools** and About - the function of Tools should be described first as follows:

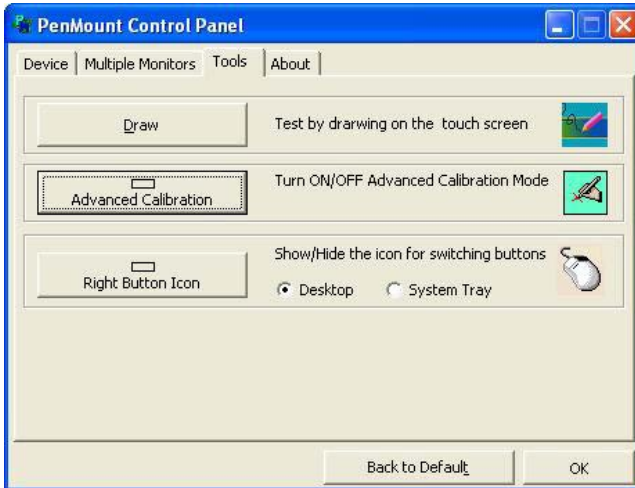

## Draw

Tests or demonstrates the PenMount touch screen operation.

## Advanced Calibration

Enable Advanced Calibration function.

## Right Button Icon

Enable right button function. The icon can be shown on Desktop or in the system tray at the bottom-right corner.

## The Device Tab

In this window, you can find out how many devices are detected on your system. On the **Device** tab, select the device icon and tap **Configure**, or double tap the device icon for touch screen calibration.

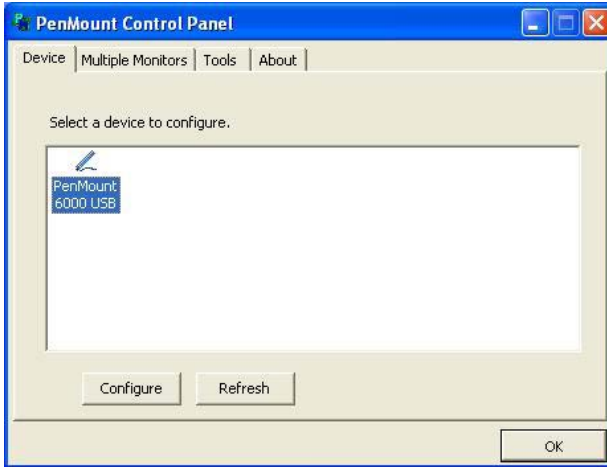

And then another window with the **Calibrate** tab appears.

## Device Calibration Dialog

### The Calibrate Tab

This function offers two ways to calibrate your touch screen. '**Standard Calibration**' adjusts most touch screens while '**Advanced Calibration**' adjusts aging touch screens.

### Standard Calibration

The Standard Calibration function lets you match the touch screen to your display so that the point you touch is accurately tracked on screen. Standard Calibration only requires four points for calibration and one point for confirmation. Under normal circumstance Standard Calibration is all you need to perform an accurate calibration.

By default, only the Standard Calibration button is available.

1. Please tap the Standard Calibration button to start calibration procedures.

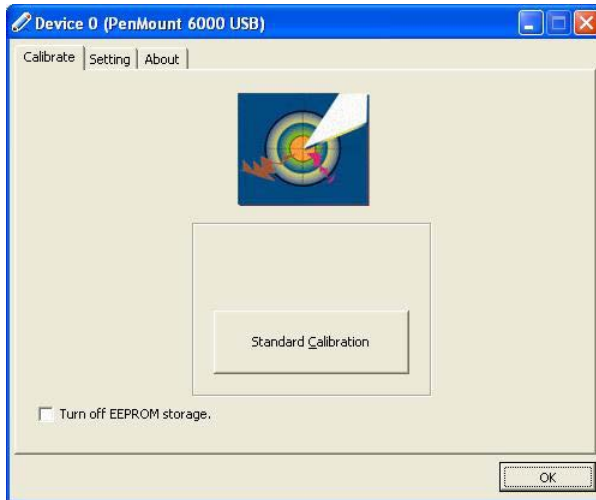

2. After tapping the button, the arrow appears pointing to a red square. Use your finger or stylus to touch the red square and hold down until the screen shows the message - "Lift off to proceed".
3. And then the next arrow appears. After the fifth red point calibration is complete, the program will jump out automatically, or you may press ESC key to quit it manually.

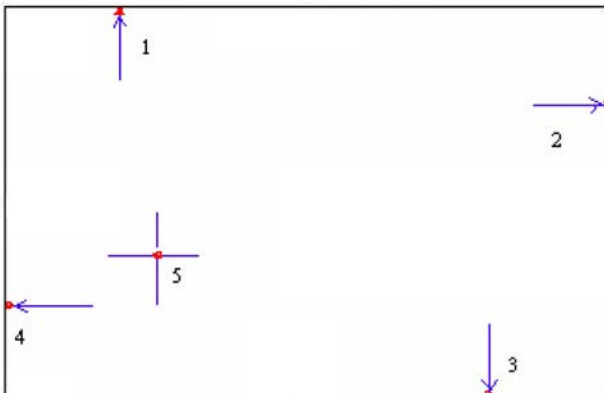

Note: The older the touch screen gets, the more Advanced Mode calibration points you need for an accurate calibration. Use a stylus during Advanced Calibration for better accuracy. Please follow the step as below:

### Advanced Calibration

The Advanced Calibration function improves the accuracy of calibration by using more involved engineering calculations. Use this function only if you have tried the Standard Calibration and there is still a discrepancy in the way the touch screen maps to the display. You can choose 4, 9, 16 or 25 points to calibrate, though we suggest that you first try 9 points, if it is still not tracking well then try 16 or 25 points. The more points you use for calibration, the greater the accuracy is. Errors in calibration may occur due to viewing angle, or individual skill, and there may be little difference in using 16 or 25 points. Note that a stylus is recommended for most accurate results.

1. Come back to PenMount Control Panel and select the **Tools** tab. Tap the Advanced Calibration button to enable it (when enabled, the small rectangle in the middle appears in yellow).

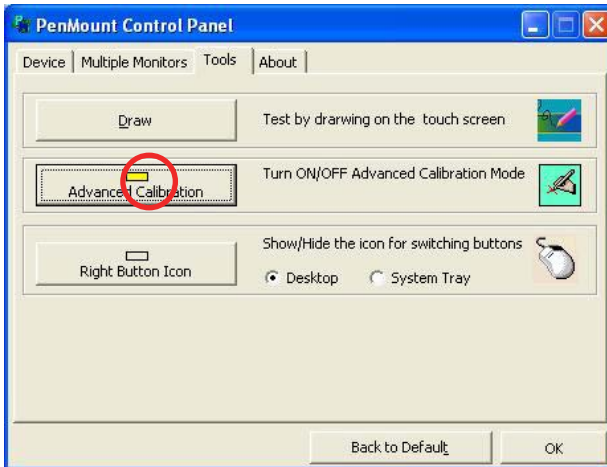



2. Select **Device** to calibrate, and then you can start to do "Advanced Calibration". Tap the arrow to pull down the drop-down menu and select the number determining how many points will be used for calibration.

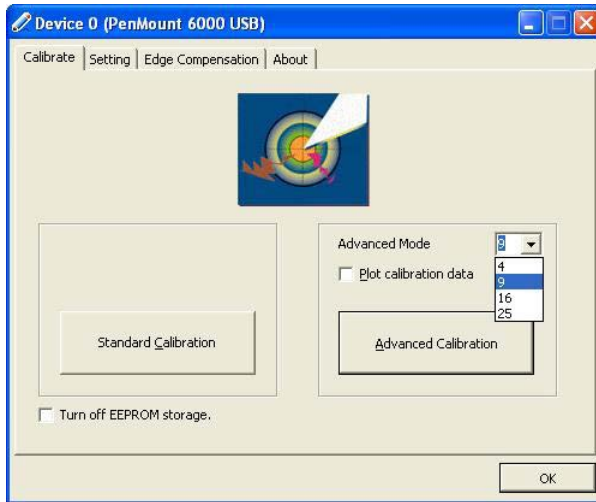

Note: You are recommended to use a stylus during Advanced Calibration for greater accuracy.

3. After tapping the button, a crosshair will appear on screen. Use your finger or stylus to touch the red spot inside it and hold down until the screen shows this message - "Lift off to proceed" and then the next crosshair will appear. After all crosshairs are clicked, the program will jump out automatically, or you may press ESC key to quit it manually.

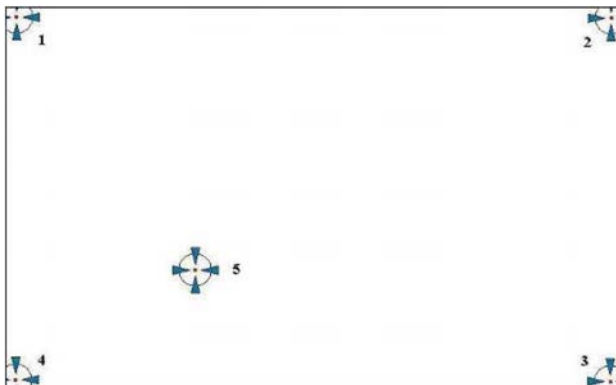

## Plot Calibration Data

Check this function to have touch panel linearity comparison graph appear when you finish Advanced Calibration. The black lines reflect the ideal linearity assumed by PenMount's application program while the blue lines show the approximate linearity calculated by PenMount's application program as the result of user's execution of Advance Calibration.

## Turn off EEPROM storage

Tick this function to disable the write-in of calibration data in Controller.

## The Setting Tab

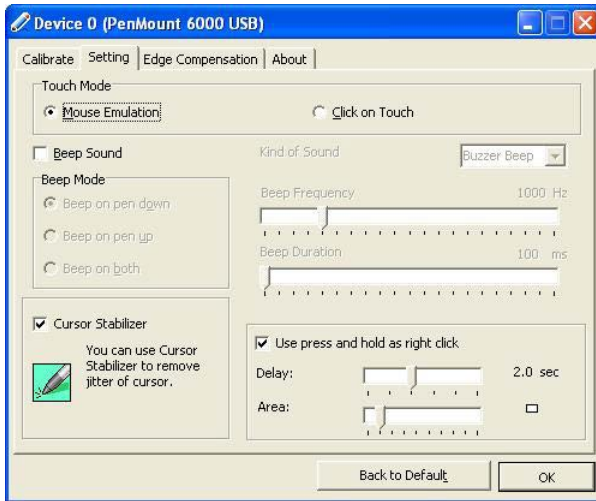

<b>Touch Mode</b>	This mode enables and disables the mouse's ability to drag on-screen icons.
<b>Mouse Emulation</b>	Select this mode and the mouse functions as normal and allows dragging of icons.
<b>Click on Touch</b>	Select this mode and the mouse only provides a click function, and dragging is disabled.

<b>Beep Sound</b>	Turn On/Off Beep Sound.
<b>Beep on Pen Down</b>	Beep occurs when pen is down.
<b>Beep on Pen Up</b>	Beep occurs when pen is up.
<b>Beep on Both</b>	Beep occurs when pen is down or up.
<b>Beep Frequency</b>	Modifies sound frequency.
<b>Beep Duration</b>	Modifies sound duration.
<b>Cursor Stabilizer</b>	Enable the function supporting to prevent cursor shake.
<b>Use press and hold as right click</b>	You can set the time out and area as you need.

## The Edge Compensation Tab

This tab is the edge compensation settings for the advanced calibration. You can adjust the settings from 0 to 30 for accommodating the difference of each touch panel.

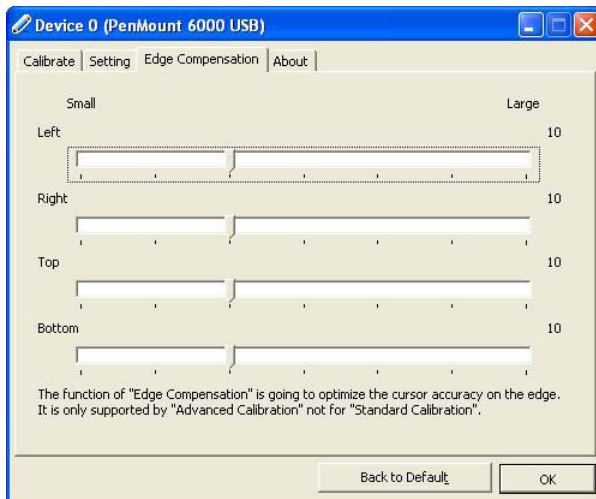

---

This page is intentionally left blank.